

# Series AX

## Standard Type/Double Acting : Single Rod

Bore Size(mm) : Ø20, Ø25, Ø32, Ø40



- STAINLESS STEEL BODY
- HIGH CYCLE LIFE
- LOW BREAKAWAY
- NUMEROUS MOUNTING OPTIONS
- MAGNET STANDARD FOR AUTO SWITCH
- BUMPERS STANDARD (AIR CUSHION OPTIONAL)
- DESIGNED FOR NON-LUBRICATED SERVICE
- COMPACT LIGHT DESIGN
- REPLACEABLE ROD GLAND

Symbol

Double acting/Single rod

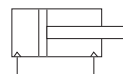

### How to Order

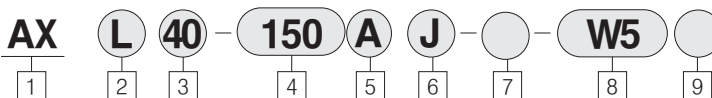

#### 1 Air Cylinder

\* Built-in Magnet standard

#### 2 Mounting

- B : Basic type
- L : Axial foot type
- F : Rod side flange type
- G : Head side flange type
- C : Single clevis type
- D : Double clevis type
- T : Head side trunnion type
- U : Rod side trunnion type
- E : Integrated clevis type
- BZ : Boss-cut basic type
- FZ : Boss-cut flange type
- UZ : Boss-cut trunnion type

#### 3 Bore Size(mm)

- 20 : φ 20
  - 25 : φ 25
  - 32 : φ 32
  - 40 : φ 40
- #### 4 Stroke(mm)
- φ 20 : 25, 50, 75, 100, 125, 150, 200, 250, 300
  - φ 25 : 25, 50, 75, 100, 125, 150, 200, 250, 300
  - φ 32 : 25, 50, 75, 100, 125, 150, 200, 250, 300
  - φ 40 : 25, 50, 75, 100, 125, 150, 200, 250, 300

#### 5 Cushion

- Blank : Rubber Cushion
- A : Air Cushion
- \* Compact Type : Only Rubber Cushion

#### 6 Rod Boot Option

Blank : None

J : Nylon Tarpaulin  
K : Neoprene Cloth

Max. Ambient Temperature

J	60°C (140°F)
K	* 110°C (230°F)

\* The Max. Ambient Temperature of Gaiters Only

\* When knuckles are ordered  
I : Single knuckle are ordered  
Y : Double knuckle attached

#### 7 Special Option

- Blank : Standard Type
- XC16 : Copper-Free

#### 8 Auto Switch

- (Band mounted type)
- Blank : None
- W5 : Reed Switch(Lead wire of 0.5m)
- W5L : Reed Switch(Lead wire of 3m)

#### 9 Number of Auto Switches

- Blank : 2 pcs
- S : 1 pc
- N : N pcs

#### PART No. of Mounting Bracket

Bore Size(mm)	φ 20	φ 25	φ 32	φ 40
*Axial foot	TCM-L020B	TCM-L032B	TCM-L040B	
Flange	TCM-F020B	TCM-F032B	TCM-F040B	
Single Clevis	TCM-C020B	TCM-C032B	TCM-C040B	
Double Clevis	TCM-D020B	TCM-D032B	TCM-D040B	
Trunnion(With nut)	TCM-T020B	TCM-T032B	TCM-T040B	

\* 2 pcs. Required Per Cylinder

#### PART No. of Auto Switch Mounting Band

Auto Switch Model	Bore Size(mm)			
	φ 20	φ 25	φ 32	φ 40
W5	TBM2-020	TBM2-025	TBM2-032	TBM2-040

\* Refer to P.598 for information on Rod end form change.

ACP

APM

AS

**AX**

AM2

AM

AL  
ALX

AQ  
ADQ

AQ2  
ADQ2

AJ  
AJM

ABK

ACK1

NSK

AG

NGQ

AGX  
GX

NP

ADR

AMR

NDM

ARD

NST

AST

ASTH

NLCD

NLCS

## Series AX

Model				
Bore Size (mm)	φ20	φ25	φ32	φ40
Type	Air Cylinder			
Cushion	Rubber Cushion, Air Cushion			
Piping Method	1/8 Rc(PT)	1/8 Rc(PT)	1/8 Rc(PT)	1/4 Rc(PT)
Magnet	Built Magnet standard			
Auto switch (Band Mounting Type)	Reed Auto Switch / W5			
Rod Boot	Non, Nylon Tarpaulin : 60℃(140°F) Neopren Cloth : 110℃(230°F)			

Specifications	
Action	Double Acting Single Rod
Fluid	Air
Proof Pressure	1.5MPa (213psi)
Max. Operating Pressure	1.0MPa (140psi)
Min. Operating Pressure	0.05MPa (7psi)
Ambient and Fluid Temperature	-10~+70 °C (14~158 °F)
Lubrication	None (Non-Lube)
Thread Tolerance	KS 2 Class
Stroke Tolerance	$^{+1.4}_0$ mm

Piston Speed (Rubber Cushion)				
Bore Size (mm)	φ20	φ25	φ32	φ40
Piston Speed	50~750 mm/sec			
Allowable Kinetic Energy(kgf-cm)	2.7	4	6.5	12

Auto Switch Specifications		
Mounting	Lead Wire Entry	Reed Switch
Band Mounting Type	Grommet	W5

Material of Boot	
Material of Boot	Max. Ambient Temperature
Nylon Tarpaulin	60℃(140°F)
Neoprene Cloth	110℃(230°F)

## Boss-Cut Type

Boss for the head cover bracket is eliminated and the total length of the cylinder is shortened.

### Compared to The Total Length of Cylinder

(Compared to The Basic Type)

φ 20	φ 25	φ 32	φ 40
▼13	▼13	▼13	▼16

### Mounting

- Boss-Cut Basic Type(BZ) ● Boss-Cut Flange Type(FZ)
- Boss-Cut Trunnion Type(UZ)

## Mounting and Accessovies

Accessories Mounting	Standard			Option		
	Mounting Nut	Rod End Nut	Clevis Pin	Single Knuckle Joint	Double Knuckle Joint	Boot
Basic Type	○(1pc.)	○	—	○	○	○
Axial Foot Type	○(2)	○	—	○	○	○
Rod Side Flange Type	○(1)	○	—	○	○	○
Head Side Flange Type	○(1)	○	—	○	○	○
Integrated Clevis Type	—	○	—	○	○	○
Single Clevis Type	—	○	—	○	○	○
Double Clevis Type	—	○	○	○	○	○
Head Side Trunnion Type	○(1)	○	—	○	○	○
Rod Side Trunnion Type	○(1)	○	—	○	○	○
Boss-Cut Basic Type	○(1)	○	—	○	○	○
Boss-Cut Flange Type	○(1)	○	—	○	○	○
Boss-Cut Trunnion Type	○(1)	○	—	○	○	○
Note					With pin	

## Weight Table

kgf (lbf)

Bore Size(mm)		φ 20	φ 25	φ 32	φ 40
Basic Weight	Basic Type	0.14(0.31)	0.21(0.46)	0.28(0.62)	0.56(1.23)
	Axial Foot Type	0.29(0.64)	0.37(0.82)	0.45(0.97)	0.83(1.83)
	Flange Type	0.20(0.44)	0.31(0.66)	0.37(0.82)	0.68(1.5)
	Integrated Clevis Type	0.12(0.26)	0.19(0.42)	0.27(0.6)	0.52(1.15)
	Single Clevis Type	0.18(0.4)	0.25(0.55)	0.32(0.71)	0.65(1.43)
	Double Clevis Type	0.19(0.42)	0.26(0.6)	0.33(0.73)	0.68(1.52)
	Trunnion Type	0.18(0.4)	0.28(0.62)	0.34(0.75)	0.66(1.46)
	Boss-Cut basic Type	0.13(0.29)	0.19(0.42)	0.26(0.57)	0.53(1.17)
	Boss-Cut flange Type	0.19(0.42)	0.28(0.62)	0.35(0.77)	0.65(1.43)
Additional weight for each 50 of stroke		0.04(0.09)	0.06(0.13)	0.08(0.18)	0.13(0.29)
Mounting bracket	Single Knuckle Joint	0.06(0.13)	0.06(0.13)	0.07(0.13)	0.23(0.51)
	Double Knuckle Joint	0.07(0.15)	0.07(0.15)	0.07(0.15)	0.21(0.44)

### Calculation Example: AXL32-100

- Basic weight : 0.44 (Foot type, φ 32)
  - Additional weight : 0.08/50 stroke
  - Cylinder stroke: 100 stroke
- $$0.44 + 0.08 \times 100/50 = 0.06\text{kgf}$$

ACP

APM

AS

**AX**

AM2

AM

AL  
ALX

AQ  
ADQ

AQ2  
ADQ2

AJ  
AJM

ABK

ACK1

NSK

AG

NGQ

AGX  
GX

NP

ADR

AMR

NDM

ARD

NST

AST

ASTH

NLCD

NLCS

# Series AX

## Boss - Cut Type

AX ○ Z (Bore Size) — (Stroke) (Boot)



### Specifications

Action	Double Acting Single Rod
Bore Size (mm)	φ 20, φ 25, φ 32, φ 40
Max. Operating Pressure	1.0MPa (140psi)
Min. Operating Pressure	0.18MPa (25psi)
Piston Speed	0.5~300 mm/sec
Cushion	Rubber cushion (standard)
Piping Method	Screwed type
Mounting	Basic Type, Rod Side Flange Type, Head Side Flange Type, Rod Side Trunnion Type.

※ Auto Switch Available.

## With Air Cushion

AX (Mounting) (Bore Size) — (Stroke) A (Boot)

With Air Cushion ●



### Specifications

Action	Double Acting Single Rod
Bore Size(mm)	φ 20, φ 25, φ 32, φ 40
Max. Operating Pressure	1.0MPa (140psi)
Min. Operating Pressure	0.05MPa (7psi)
Cushion	Air Cushion
Piping Method	Screwed Type
Piston Speed	50~1,000 mm/sec
Mounting	Basic Type, Axial Foot Type, Rod Side Flange Type, Head Side Flange Type, Single Clevis Type, Double Clevis Type, Head Side Trunnion Type, Rod Side Trunnion Type, Integrated Clevis Type, Boss-Cut Type.

※ Auto Switch Available.

### Cushion Mechanism

Bore size (mm)	Effective Cushion Length (mm)	Cushion Effective Orifice (cm <sup>2</sup> )	Allowable Kinetic Energy (kgf-cm)
φ 20	11.0	2.09	5.5
φ 25	11.0	3.30	8.0
φ 32	11.0	5.86	13
φ 40	11.8	9.08	24

Construction/Parts List

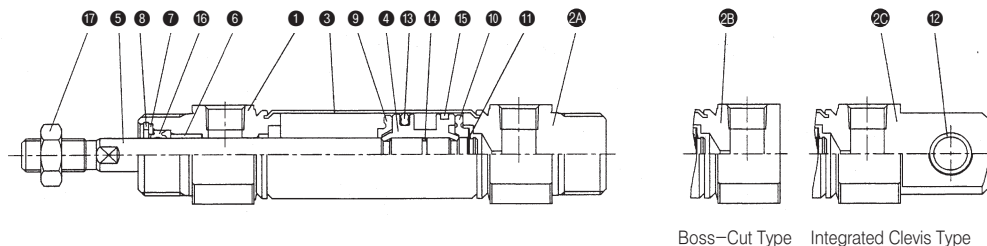

With Air Cushion

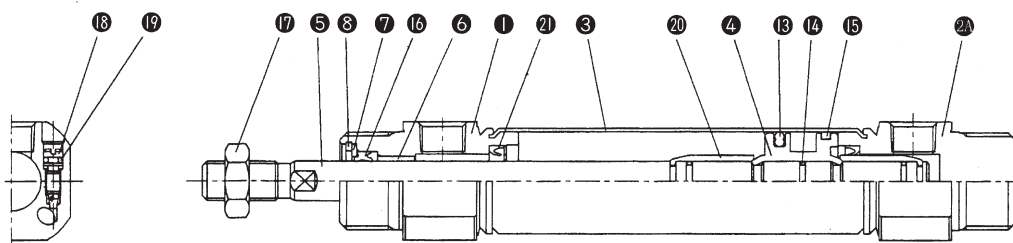

Parts List

No.	Description	Material	Note
1	Rod Cover	Aluminum Alloy	White Alumite
2A	Head Cover A	Aluminum Alloy	White Alumite (Standard type)
2B	Head Cover B	Aluminum Alloy	White Alumite (Boss-cut type)
2C	Head Cover C	Aluminum Alloy	White Alumite (Integrated clevis type)
3	Cylinder Tube	Stainless Steel	
4	Piston	Aluminum Alloy	Chromate
5	Piston Rod	Carbon Steel	Hard Chrome Plated
6	Bush	Lead Bronze Casting	
7	Packing Retainer	Rolled Steel	Nickel Plated
8	Retaining Pin	Carbon Steel	Nickel Plated
9	Damper A	Urethane	
10	Damper B	Urethane	
11	Stopper Ring	Carbon Steel	

No.	Description	Material	Note
12	Clevis Bush	Lead Bronze Casting	
13	Piston Packing	NBR	
14	Piston Gasket	NBR	
15	Wearing	Resin	
17	Rod Nut	Nickel Plated	
18	Cushion Value Gasket	NBR	
19	Cushion Ring		
20	Cushion Packing	NBR	

Spare Parts/Packing List

Rubber Cushion / Air Cushion

No.	Description	Material	Type	Bore Size			
				20	25	32	40
18	Rod Packing	NBR	Rubber Cushion	PDU-8LZ	PDU-10LZ	PDU-12LZ	PDU-14LZ
			Air Cushion	PDU-8Z	PDU-10Z	PDU-12Z	PDU-14Z

- ACP
- APM
- AS
- AX**
- AM2
- AM
- AL  
ALX
- AQ  
ADQ
- AQ2  
ADQ2
- AJ  
AJM
- ABK
- ACK1
- NSK
- AG
- NGQ
- AGX  
GX
- NP
- ADR
- AMR
- NDM
- ARD
- NST
- AST
- ASTH
- NLCD
- NLCS

# Series AX

## Basic Type (B)

AXB Bore Size Stroke

### Standard Type

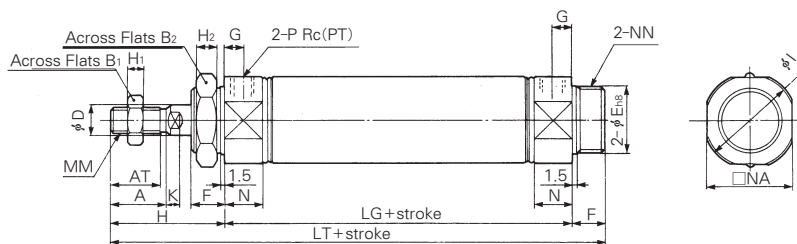

### Rod Boot

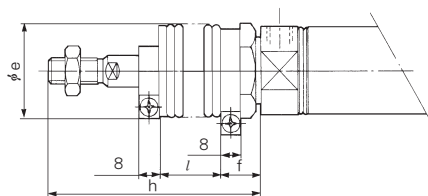

### With Air Cushion

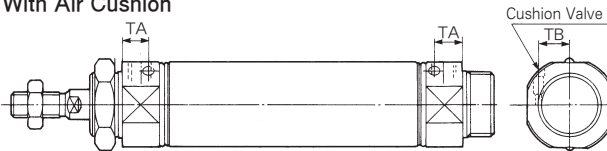

### Boss-Cut Type

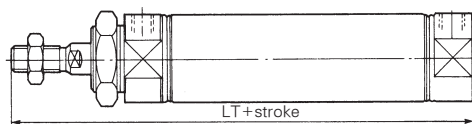

(Unit : mm)

Bore Size	Stroke Range	A	AT	B <sub>1</sub>	B <sub>2</sub>	D	E	F	G	H	H <sub>1</sub>	H <sub>2</sub>	I	K	MM	N	NA	NN	P	LG	LT
φ 20	~300	18	15.5	13	26	8	20 <sup>0</sup> <sub>-0.033</sub>	13	8	41	5	8	27	5	M8×1.25	15	24	M20×1.5	1/8	62	116
φ 25	~300	22	19.5	17	32	10	26 <sup>0</sup> <sub>-0.033</sub>	13	8	45	6	8	33	5.5	M10×1.25	15	30	M26×1.5	1/8	62	120
φ 32	~300	22	19.5	17	32	12	26 <sup>0</sup> <sub>-0.033</sub>	13	8	45	6	8	37.5	5.5	M10×1.25	15	34.5	M26×1.5	1/8	64	122
φ 40	~300	24	21	22	41	14	32 <sup>0</sup> <sub>-0.039</sub>	16	11	50	8	10	46.5	7	M14×1.5	21.5	42.5	M32×2	1/4	88	154

### With Boot

(Unit : mm)

Bore Size	e	f	h							l						
			1~50	51~100	101~150	151~200	201~300	301~400	401~500	1~50	51~100	101~150	151~200	201~300	301~400	401~500
φ 20	30	16	68	81	93	106	131	156	—	12.5	25	37.5	50	75	100	—
φ 25	30	16	72	85	97	110	135	160	185	12.5	25	37.5	50	75	100	125
φ 32	30	16	72	85	97	110	135	160	185	12.5	25	37.5	50	75	100	125
φ 40	40	18	77	90	102	115	140	165	190	12.5	25	37.5	50	75	100	125

### Boss-Cut Type

Bore Size	LT
φ 20	103
φ 25	107
φ 32	109
φ 40	138

### With Air Cushion

Bore Size	TA	TB
φ 20	11.5	8.5
φ 25	11.5	10
φ 32	11.5	11.5
φ 40	14.5	15

Axial Foot Type(L)

AXL Bore Size Stroke

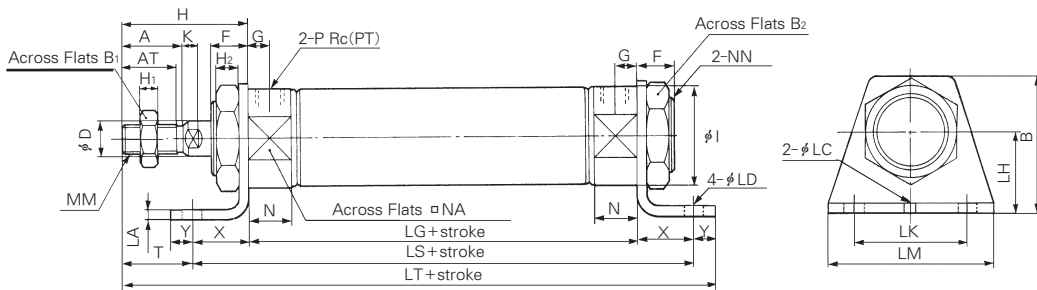

With Air Cushion

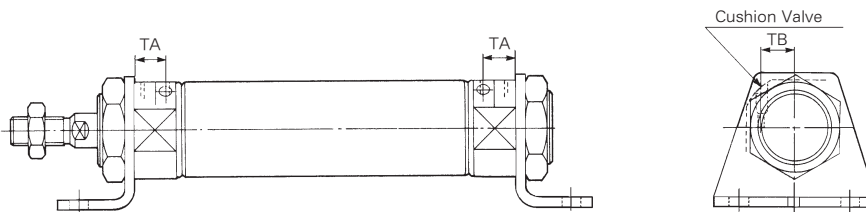

(Unit : mm)

Bore Size	Stroke Range	A	AT	B	B <sub>1</sub>	B <sub>2</sub>	D	F	G	H	H <sub>1</sub>	H <sub>2</sub>	I	K	LC	LD	LH	LS	LA	LK	LM	MM	N	NA	NN	P	LG	X	Y	T	LT
φ 20	~400	18	15.5	40	13	26	8	13	8	41	5	8	27	5	4	6.8	25	102	3.2	40	55	M8×1.25	15	24	M20×1.5	1/8	62	20	8	21	131
φ 25	~450	22	19.5	47	17	32	10	13	8	45	6	8	33	5.5	4	6.8	28	102	3.2	40	55	M10×1.25	15	30	M26×1.5	1/8	62	20	8	25	135
φ 32	~450	22	19.5	47	17	32	12	13	8	45	6	8	37.5	5.5	4	6.8	28	104	3.2	40	55	M10×1.25	15	34.5	M26×1.5	1/8	64	20	8	25	137
φ 40	~500	24	21	54	22	41	14	16	11	50	8	10	46.5	7	4	7	30	134	3.2	55	75	M14×1.5	21.5	42.5	M32×2	1/4	88	23	10	27	171

With Air Cushion

Bore Size	TA	TB
φ 20	11.5	8.5
φ 25	11.5	10
φ 32	11.5	11.5
φ 40	14.5	15

- ACP
- APM
- AS
- AX**
- AM2
- AM
- AL
- ALX
- AQ
- ADQ
- AQ2
- ADQ2
- AJ
- AJM
- ABK
- ACK1
- NSK
- AG
- NGQ
- AGX
- GX
- NP
- ADR
- AMR
- NDM
- ARD
- NST
- AST
- ASTH
- NLCD
- NLCS

# Series AX

## Rod Side Flange Type (F)

AXF Bore Size Stroke

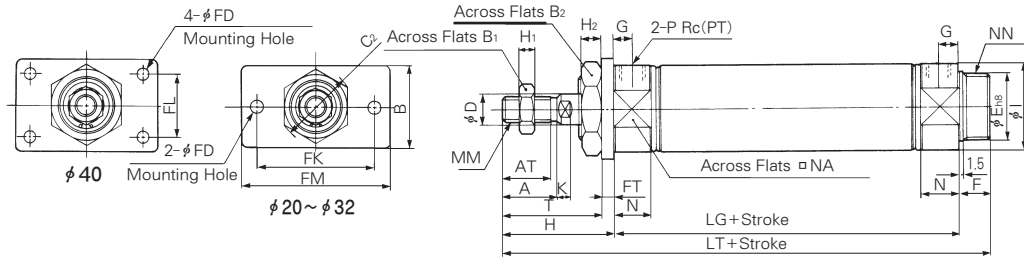

### Boss-Cut Type

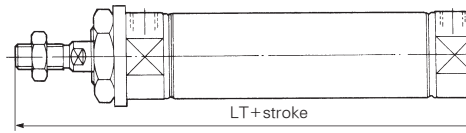

### With Air Cushion

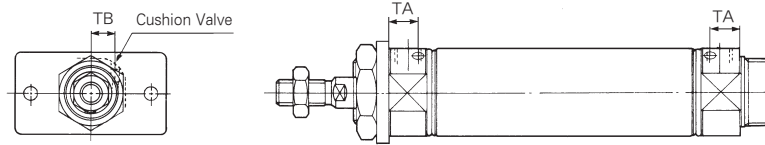

(Unit : mm)

Bore Size	Stroke Range	A	AT	B	B <sub>1</sub>	B <sub>2</sub>	C <sub>2</sub>	D	E	F	FD	FT	FK	FL	FM	G	H	H <sub>1</sub>	H <sub>2</sub>	I	K	MM
φ 20	~400	18	15.5	34	13	26	30	8	20 <sup>0</sup> <sub>-0.033</sub>	13	7	4	60	—	75	8	41	5	8	27	5	M8×1.25
φ 25	~450	22	19.5	40	17	32	37	10	26 <sup>0</sup> <sub>-0.033</sub>	13	7	4	60	—	75	8	45	6	8	33	5.5	M10×1.25
φ 32	~450	22	19.5	40	17	32	37	12	26 <sup>0</sup> <sub>-0.033</sub>	13	7	4	60	—	75	8	45	6	8	37.5	5.5	M10×1.25
φ 40	~500	24	21	52	22	41	47.3	14	32 <sup>0</sup> <sub>-0.039</sub>	16	7	5	66	36	82	11	50	8	10	46.5	7	M14×1.5

(Unit : mm)

Bore Size	N	NA	NN	P	LG	T	LT
φ 20	15	24	M20×1.5	1/8	62	37	116
φ 25	15	30	M26×1.5	1/8	62	41	120
φ 32	15	34.5	M26×1.5	1/8	64	41	122
φ 40	21.5	42.5	M32×2	1/4	88	45	154

### Boss-Cut Type

Bore Size	LT
φ 20	103
φ 25	107
φ 32	109
φ 40	138

### With Air Cushion

Bore Size	TA	TB
φ 20	11.5	8.5
φ 25	11.5	10
φ 32	11.5	11.5
φ 40	14	15



Head Side Flange Type (G)

AXG (Bore Size) (Stroke) ○

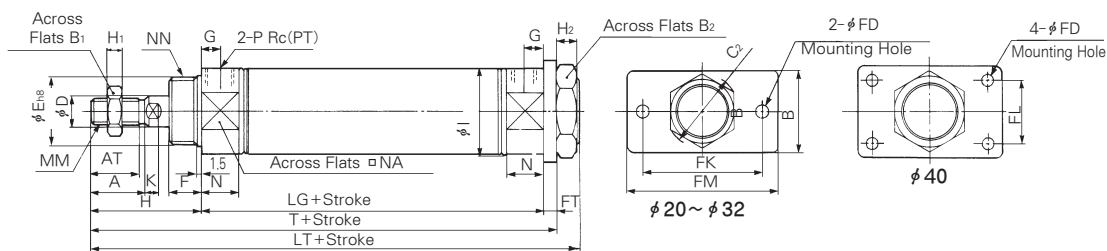

With Air Cushion

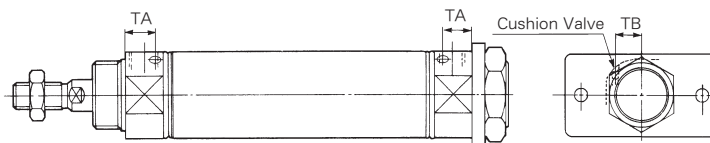

(Unit : mm)

Bore Size	Stroke Range	A	AT	B	B <sub>1</sub>	B <sub>2</sub>	C <sub>2</sub>	D	E	F	FD	FT	FK	FL	FM	G	H	H <sub>1</sub>	H <sub>2</sub>	I
$\phi 20$	~300	18	15.5	34	13	26	30	8	20 <sup>0</sup> <sub>-0.033</sub>	13	7	4	60	-	75	8	41	5	8	27
$\phi 25$	~300	22	19.5	40	17	32	37	10	26 <sup>0</sup> <sub>-0.033</sub>	13	7	4	60	-	75	8	45	6	8	33
$\phi 32$	~300	22	19.5	40	17	32	37	12	26 <sup>0</sup> <sub>-0.033</sub>	13	7	4	60	-	75	8	45	6	8	37.5
$\phi 40$	~300	24	21	52	22	41	47.3	14	32 <sup>0</sup> <sub>-0.039</sub>	16	7	5	66	36	82	11	50	8	10	46.5

(Unit : mm)

Bore Size	K	MM	N	NA	NN	P	LG	T	LT
$\phi 20$	5	M8×1.25	15	24	M20×1.5	1/8	62	107	116
$\phi 25$	5.5	M10×1.25	15	30	M26×1.5	1/8	62	111	120
$\phi 32$	5.5	M10×1.25	15	34.5	M26×1.5	1/8	64	113	122
$\phi 40$	7	M14×1.5	21.5	42.5	M32×2	1/4	88	143	154

With Air Cushion

Bore Size	TA	TB
$\phi 20$	11.5	8.5
$\phi 25$	11.5	10
$\phi 32$	11.5	11.5
$\phi 40$	14.5	15

- ACP
- APM
- AS
- AX**
- AM2
- AM
- AL
- ALX
- AQ
- ADQ
- AQ2
- ADQ2
- AJ
- AJM
- ABK
- ACK1
- NSK
- AG
- NGQ
- AGX
- GX
- NP
- ADR
- AMR
- NDM
- ARD
- NST
- AST
- ASTH
- NLCD
- NLCS

# Series AX

## Single Clevis Type (C)

AXC  Bore Size  Stroke

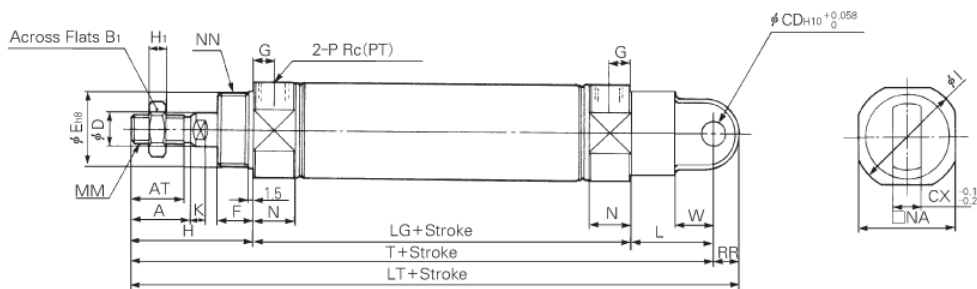

### With Air Cushion

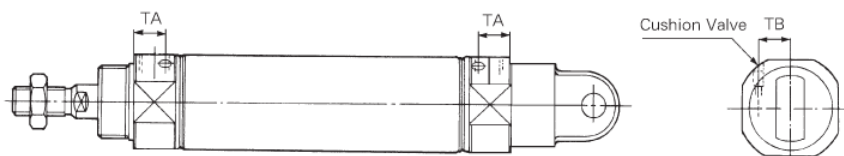

(Unit : mm)

Bore Size	Stroke Range	A	AT	B <sub>1</sub>	CD	CX	D	E	F	G	H	H <sub>1</sub>	I	K	L	MM
φ 20	~300	18	15.5	13	9	10	8	20 <sup>0</sup> <sub>-0.033</sub>	13	8	41	5	27	5	30	M8×1.25
φ 25	~300	22	19.5	17	9	10	10	26 <sup>0</sup> <sub>-0.033</sub>	13	8	45	6	33	5.5	30	M10×1.25
φ 32	~300	22	19.5	17	9	10	12	26 <sup>0</sup> <sub>-0.033</sub>	13	8	45	6	37.5	5.5	30	M10×1.25
φ 40	~300	24	21	22	10	15	14	32 <sup>0</sup> <sub>-0.039</sub>	16	11	50	8	46.5	7	39	M14×1.5

(Unit : mm)

Bore Size	N	NA	NN	P	RR	LG	W	T	LT
φ 20	15	24	M20×1.5	1/8	9	62	14	133	142
φ 25	15	30	M26×1.5	1/8	9	62	14	137	146
φ 32	15	34.5	M26×1.5	1/8	9	64	14	139	148
φ 40	21.5	42.5	M32×2	1/4	11	88	18	177	188

### With Air Cushion

Bore Size	TA	TB
φ 20	11.5	8.5
φ 25	11.5	10
φ 32	11.5	11.5
φ 40	14.5	15

Double Clevis Type (D)

AXD Bore Size Stroke

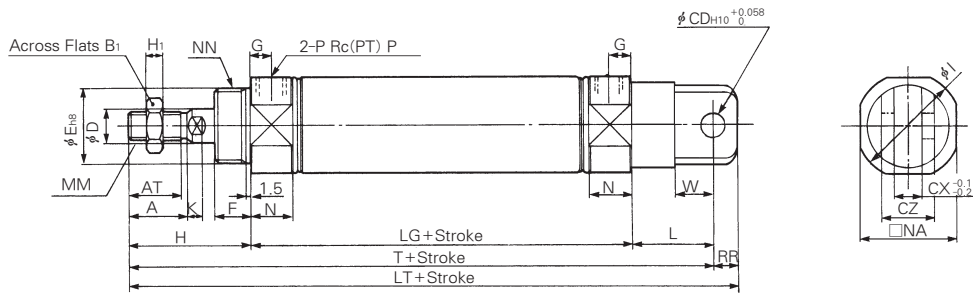

With Air Cushion

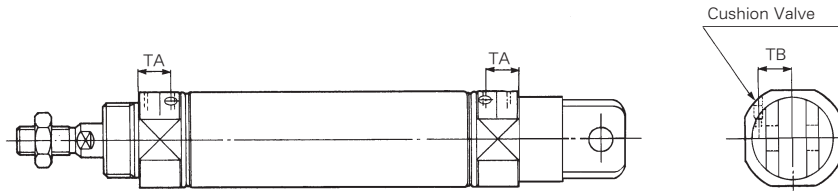

(Unit : mm)

Bore Size	Stroke Range	A	AT	B <sub>1</sub>	CD	CX	CZ	D	E	F	G	H	H <sub>1</sub>	I	K	L	MM	N	NA	NN	P	RR	LG	W	T	LT
φ 20	~300	18	15.5	13	9	10	19	8	20 <sup>0</sup> <sub>-0.033</sub>	13	8	41	5	27	5	30	M8×1.25	15	24	M20×1.5	1/8	9	62	14	133	142
φ 25	~300	22	19.5	17	9	10	19	10	26 <sup>0</sup> <sub>-0.033</sub>	13	8	45	6	33	5.5	30	M10×1.25	15	30	M26×1.5	1/8	9	62	14	137	146
φ 32	~300	22	19.5	17	9	10	19	12	26 <sup>0</sup> <sub>-0.033</sub>	13	8	45	6	37.5	5.5	30	M10×1.25	15	34.5	M26×1.5	1/8	9	64	14	139	148
φ 40	~300	24	21	22	10	15	30	14	32 <sup>0</sup> <sub>-0.039</sub>	16	11	50	8	46.5	7	39	M14×1.5	21.5	42.5	M32×2	1/4	11	88	18	177	188

With Air Cushion

Bore Size	TA	TB
φ 20	11.5	8.5
φ 25	11.5	10
φ 32	11.5	11.5
φ 40	14.5	15

- ACP
- APM
- AS
- AX
- AM2
- AM
- AL  
ALX
- AQ  
ADQ
- AQ2  
ADQ2
- AJ  
AJM
- ABK
- ACK1
- NSK
- AG
- NGQ
- AGX  
GX
- NP
- ADR
- AMR
- NDM
- ARD
- NST
- AST
- ASTH
- NLCD
- NLCS

# Series AX

## Rod Side Trunnion Type (U)

AXU Bore Size Stroke

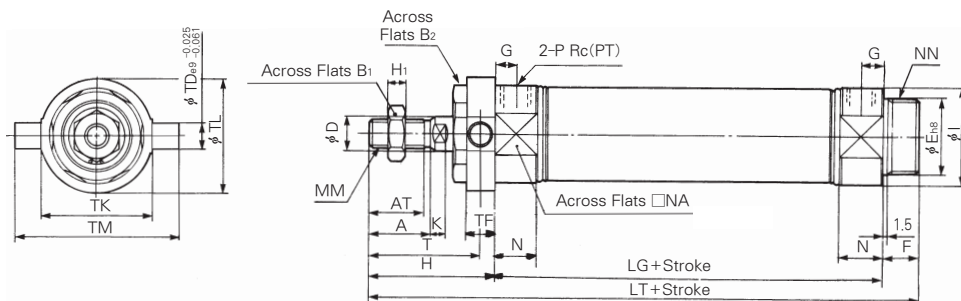

## Boss-Cut Type

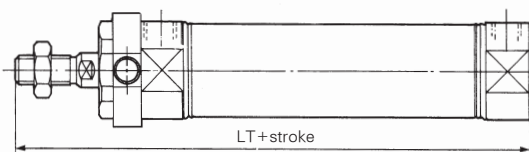

## With Air Cushion

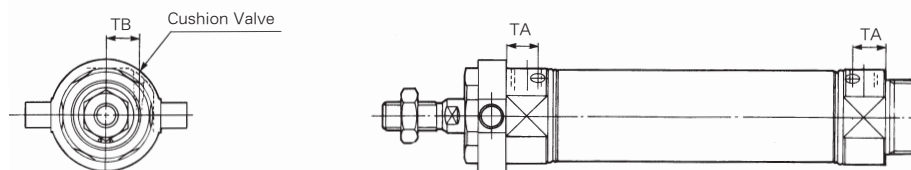

(Unit : mm)

Bore Size	Stroke Range	A	AT	B <sub>1</sub>	B <sub>2</sub>	D	E	F	G	H	H <sub>1</sub>	I	K	MM	N	NA	NN	P
φ20	~300	18	15.5	13	26	8	20 <sup>0</sup> <sub>-0.033</sub>	13	8	41	5	27	5	M8×1.25	15	24	M20×1.5	1/8
φ25	~300	22	19.5	17	32	10	26 <sup>0</sup> <sub>-0.033</sub>	13	8	45	6	33	5.5	M10×1.25	15	30	M26×1.5	1/8
φ32	~300	22	19.5	17	32	12	26 <sup>0</sup> <sub>-0.033</sub>	13	8	45	6	37.5	5.5	M10×1.25	15	34.5	M26×1.5	1/8
φ40	~300	24	21	22	41	14	32 <sup>0</sup> <sub>-0.039</sub>	16	11	50	8	46.5	7	M14×1.5	21.5	42.5	M32×2	1/4

(Unit : mm)

Bore Size	LG	TD	TF	TK	TL	TM	T	LT
φ20	62	8	10	32	32	52	36	116
φ25	62	9	10	40	40	60	40	120
φ32	64	9	10	40	40	60	40	122
φ40	88	10	11	53	53	77	44.5	154

### Boss-Cut Type

Bore Size	LT
φ20	103
φ25	107
φ32	109
φ40	138

### With Air Cushion

Bore Size	TA	TB
φ20	11.5	8.5
φ25	11.5	10
φ32	11.5	11.5
φ40	14.5	15

Head Side Trunnion Type (T)

AXT Bore Size Stroke

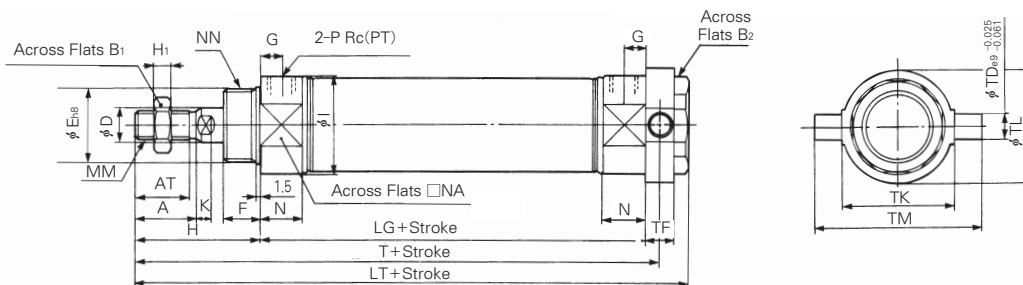

With Air Cushion

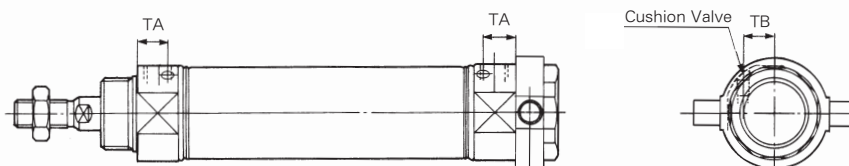

(Unit : mm)

Bore Size	Stroke Range	A	AT	B <sub>1</sub>	B <sub>2</sub>	D	E	F	G	H	H <sub>1</sub>	I	K	MM	N	NA	NN	P
φ 20	~300	18	15.5	13	26	8	20 <sup>0</sup> <sub>-0.033</sub>	13	8	41	5	27	5	M8×1.25	15	24	M20×1.5	1/8
φ 25	~300	22	19.5	17	32	10	26 <sup>0</sup> <sub>-0.033</sub>	13	8	45	6	33	5.5	M10×1.25	15	30	M26×1.5	1/8
φ 32	~300	22	19.5	17	32	12	26 <sup>0</sup> <sub>-0.033</sub>	13	8	45	6	37.5	5.5	M10×1.25	15	34.5	M26×1.5	1/8
φ 40	~300	24	21	22	41	14	32 <sup>0</sup> <sub>-0.039</sub>	16	11	50	8	46.5	7	M14×1.5	21.5	42.5	M32×2	1/4

(Unit : mm)

Bore Size	LG	TD	TF	TK	TL	TM	T	LT
φ 20	62	8	10	32	32	52	108	118
φ 25	62	9	10	40	40	60	112	122
φ 32	64	9	10	40	40	60	114	124
φ 40	88	10	11	53	53	77	143.5	154

With Air Cushion

Bore Size	TA	TB
φ 20	11.5	8.5
φ 25	11.5	10
φ 32	11.5	11.5
φ 40	14.5	15

- ACP
- APM
- AS
- AX
- AM2
- AM
- AL  
ALX
- AQ  
ADQ
- AQ2  
ADQ2
- AJ  
AJM
- ABK
- ACK1
- NSK
- AG
- NGQ
- AGX  
GX
- NP
- ADR
- AMR
- NDM
- ARD
- NST
- AST
- ASTH
- NLCD
- NLCS

# Series AX

## Integrated Clevis Type (E)

AXE  Bore Size  Stroke

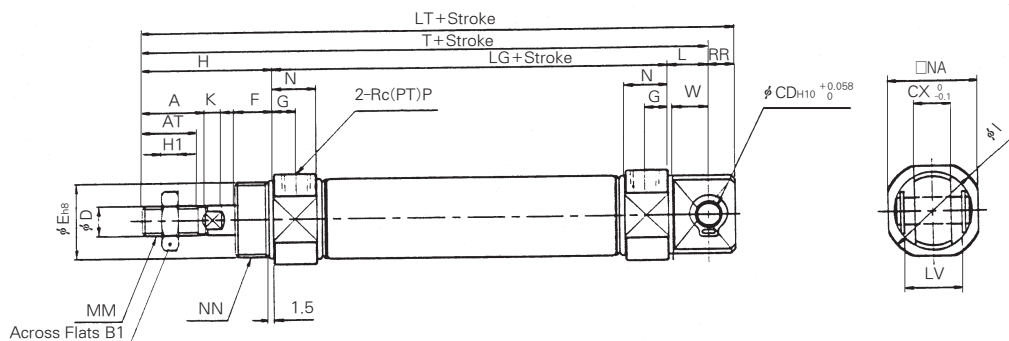

With Air Cushion

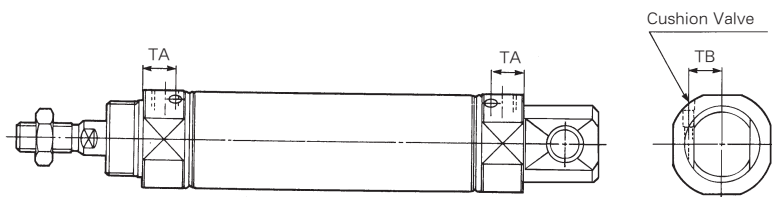

(Unit : mm)

Bore Size	Stroke Range	A	AT	B <sub>1</sub>	CD	CX	D	E	F	G	H	H <sub>1</sub>	I	K	L	MM	N	NA	NN
φ 20	~300	18	15.5	13	8	12	8	20 <sup>0</sup> <sub>-0.033</sub>	13	8	41	5	27	5	12	M8×1.25	15	24	M20×1.5
φ 25	~300	22	19.5	17	8	12	10	26 <sup>0</sup> <sub>-0.033</sub>	13	8	45	6	33	5.5	12	M10×1.25	15	30	M26×1.5
φ 32	~300	22	19.5	17	10	20	12	26 <sup>0</sup> <sub>-0.033</sub>	13	8	45	6	37.5	5.5	15	M10×1.25	15	34.5	M26×1.5
φ 40	~300	24	21	22	10	20	14	32 <sup>0</sup> <sub>-0.039</sub>	16	11	50	8	46.5	7	15	M14×1.5	21.5	42.5	M32×2

(Unit : mm)

Bore Size	P	RR	LG	W	T	LT	LV
φ 20	1/8	9	62	11.5	115	124	18.4
φ 25	1/8	9	62	11.5	119	128	18.4
φ 32	1/8	12	64	14.5	124	136	28
φ 40	1/4	12	88	14.5	153	165	28

### With Air Cushion

Bore Size	TA	TB
φ 20	11.5	8.5
φ 25	11.5	10
φ 32	11.5	11.5
φ 40	14.5	15

Accessories/Dimensions

mm

Single Knuckle Joint

(mm)

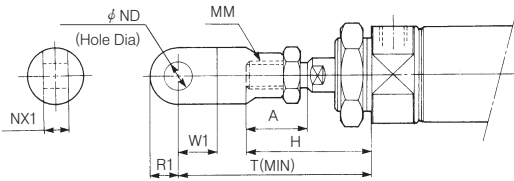

Bore Size	A	H	MM	φ ND <sup>H10</sup>	NX <sub>1</sub>	W <sub>1</sub>	R <sub>1</sub>	T
φ 20	18	41	M8×1.25	9 <sup>+0.058</sup> <sub>0</sub>	9 <sup>-0.1</sup> <sub>-0.2</sub>	14	10	66
φ 25	22	45	M10×1.25	9 <sup>+0.058</sup> <sub>0</sub>	9 <sup>-0.1</sup> <sub>-0.2</sub>	14	10	69
φ 32	22	45	M10×1.25	9 <sup>+0.058</sup> <sub>0</sub>	9 <sup>-0.1</sup> <sub>-0.2</sub>	14	10	69
φ 40	24	50	M14×1.5	12 <sup>+0.070</sup> <sub>0</sub>	16 <sup>-0.1</sup> <sub>-0.3</sub>	20	15.5	92

Single Knuckle Joint

(mm)

TI-020B, 032B  
Material : Rolled Steel

TI-040B  
Material : Free Cutting Sulfur Steel

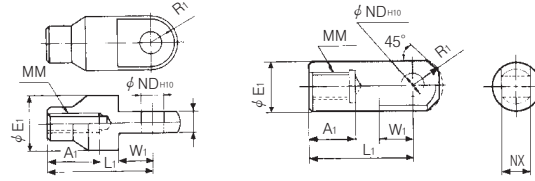

Part No.	Applicable Bore size	A <sub>1</sub>	E <sub>1</sub>	L <sub>1</sub>	MM	ND <sup>H10</sup>	NX	R <sub>1</sub>	W <sub>1</sub>
TI-020B	φ 20	16	20	36	M8×1.25	9 <sup>+0.058</sup> <sub>0</sub>	9 <sup>-0.1</sup> <sub>-0.2</sub>	10	14
TI-032B	φ 25	18	20	38	M10×1.25	9 <sup>+0.058</sup> <sub>0</sub>	9 <sup>-0.1</sup> <sub>-0.2</sub>	10	14
TI-032B	φ 32	18	20	38	M10×1.25	9 <sup>+0.058</sup> <sub>0</sub>	9 <sup>-0.1</sup> <sub>-0.2</sub>	10	14
TI-040B	φ 40	22	24	55	M14×1.5	12 <sup>+0.070</sup> <sub>0</sub>	16 <sup>-0.1</sup> <sub>-0.3</sub>	15.5	20

Double Knuckle Joint

(mm)

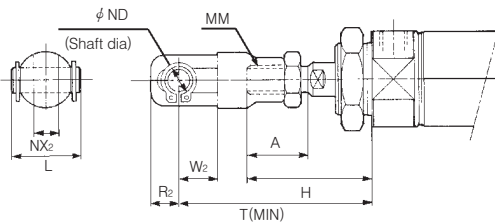

Bore Size	A	H	L	MM	φ ND <sub>d9</sub>	NX <sub>2</sub>	R <sub>2</sub>	W <sub>2</sub>	T
φ 20	18	41	25	M8×1.25	9 <sup>-0.040</sup> <sub>0.076</sub>	9 <sup>+0.2</sup> <sub>+0.1</sub>	10	14	66
φ 25 · φ 32	22	45	25	M10×1.25	9 <sup>-0.040</sup> <sub>0.076</sub>	9 <sup>+0.2</sup> <sub>+0.1</sub>	10	14	69
φ 40	24	50	49.7	M14×1.5	12 <sup>-0.050</sup> <sub>0.093</sub>	16 <sup>+0.3</sup> <sub>+0.1</sub>	13	25	92

Double Knuckle Joint

(mm)

TY-020B, 032B  
Material : Rolled steel

TY-040B  
Material : Cast iron

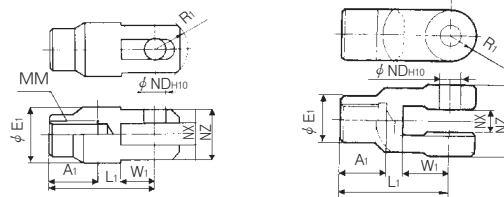

Part No.	Applicable Bore size	A <sub>1</sub>	E <sub>1</sub>	L <sub>1</sub>	MM	ND <sup>H10</sup>	NX	NZ	R <sub>1</sub>	W <sub>1</sub>	Applicable pin part NO.
TY-020B	φ 20	16	20	36	M8×1.25	9 <sup>+0.058</sup> <sub>0</sub>	9 <sup>+0.2</sup> <sub>+0.1</sub>	18	12	14	TCDP-1
TY-032B	φ 25 · φ 32	18	20	38	M10×1.25	9 <sup>+0.058</sup> <sub>0</sub>	9 <sup>+0.2</sup> <sub>+0.1</sub>	18	12	14	TCDP-1
TY-040B	φ 40	22	24	55	M14×1.5	12 <sup>+0.070</sup> <sub>0</sub>	16 <sup>+0.3</sup> <sub>+0.1</sub>	38	13	25	TCDP-3

Clevis Pin, Knuckle Pin

(mm)

Applicable Bore Size : φ 20, φ 25, φ 32

TCDP-1

Material: Carbon Steel

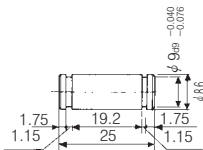

Retaining Pin: C9 Type For Pivot

Clevis Pin, Knuckle Pin

(mm)

Applicable Bore Size : φ 40

TCDP-2

Material: Carbon Steel

TCDP-3

Material: Carbon Steel

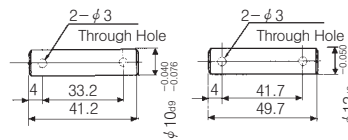

Applicable Split Pin : φ 3×18 ℓ

ACP

APM

AS

AX

AM2

AM

AL  
ALX

AQ

ADQ

AQ2

ADQ2

AJ

AJM

ABK

ACK1

NSK

AG

NGQ

AGX  
GX

NP

ADR

AMR

NDM

ARD

NST

AST

ASTH

NLCD

NLCS

# Series AX

## Accessories/Dimensions

### Rod End Nut

Material : Carbon Steel

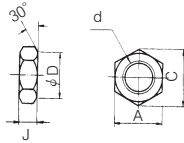

### Mounting Nut

Material : Carbon Steel

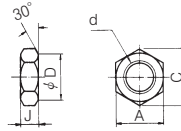

### Trunnion Nut

Material : Carbon Steel

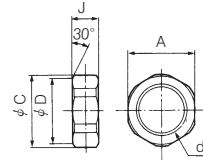

(Unit : mm)

Part No.	Applicable bore size	A	C	D	d	J
TNT-02	φ 20	13	15.5	12.5	M8×1.25	5
TNT-03	φ 25	17	19.6	16.5	M10×1.25	6
TNT-03	φ 32	17	19.6	16.5	M10×1.25	6
TNT-04	φ 40	22	25.4	21.0	M14×1.5	8

Part No.	Applicable bore size	A	C	D	d	J
TSN-020B	φ 20	26	30	25.5	M20×1.5	8
TSN-032B	φ 25	32	37	31.5	M26×1.25	8
TSN-032B	φ 32	32	37	31.5	M26×1.5	8
TSN-040B	φ 40	41	47.3	40.5	M32×2.0	10

Part No.	Applicable bore size	A	C	D	d	J
TN-020B	φ 20	26	28	25.5	M20×1.5	10
TN-032B	φ 25	32	34	31.5	M26×1.25	10
TN-032B	φ 32	32	34	31.5	M26×1.25	10
TN-040B	φ 40	41	45	40.5	M32×2	10

### Reed Switch Setting Position (Stroke End)

W5

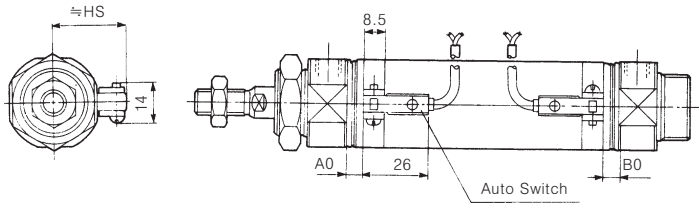

### Bore Size

Bore Size	W5		
	A0	B0	HS
φ 20	7	6	22.5
φ 25	7	6	25
φ 32	8	7	28.5
φ 40	13	12	32.5

### Auto Switch Mounting, Minimum Possible Cylinder Strokes (mm)

Auto Switch Type	No. of Auto Switch				1pc.
	2pcs.		n pcs.		
	Different Surface	Same Surface	Different Orientation	Same Orientation	
W5	15	50	$15+45\left(\frac{n-2}{2}\right)$ (n=2, 4, 6, 8...)	$50+45(n-2)$	10



## ① Adjustable Stroke Cylinder/Extension Adjustable Type

AX (Mounting) (Type) (Bore Size) (Stroke) (Additional Symbol) (Stroke Adjusting Symbol) — XC8

### Additional Symbol ●

Blank-With Boot  
 J-With Boot(Nylon Tarpaulin)  
 K-With Boot(Neoprene Cloth)

### ● Stroke Adjusting Symbol

A-Stroke Adjusting Range 0~25mm  
 B-Stroke Adjusting Range 0~50mm

The Extended Stroke of the cylinder can be adjusted by the stopper in the head side.

### Specifications

Fluid	Air
Proof Pressure	1.5MPa (213psi)
Max. Operating Pressure	1.0MPa (140psi)
Min. Operating Pressure	0.05MPa (7psi)
Piston Speed	50~750 mm/sec
Cushion	Rubber Cushion(Standard)
Stroke Adjusting System	Adjusting Stopper
Stroke Adjusting Range	A : 0~25mm, B : 0~50mm
Mounting	Basic Type, Axial Foot Type, Rod Side Flange Type, Head Side Flange Type, Rod Side Trunnion Type
Applicable Bore Size(mm)	φ 20, φ 25, φ 32, φ 40

### Symbol

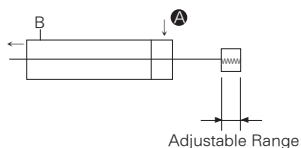

### Construction, Dimensions/Basic Type

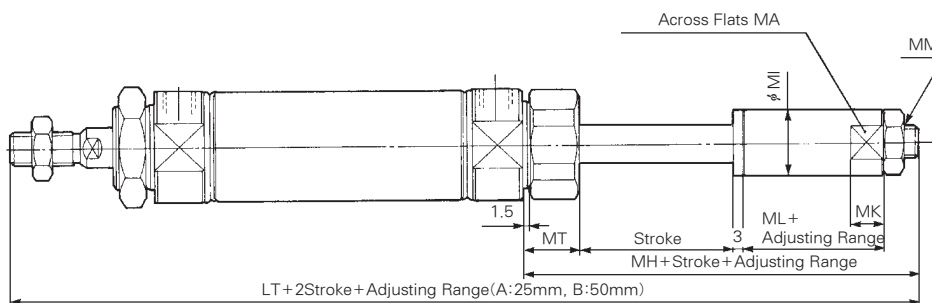

(Unit: mm)

Bore Size	MA	MK	MI	MM	MT	MH	ML	LT
φ 20	12	8	15	M8×1.25	16.5	47	18	150
φ 25	17	10	20	M8×1.25	17.5	49	18	156
φ 32	17	10	20	M10×1.25	17.5	49	18	158
φ 40	22	12	25	M14×1.5	21.5	60	22	198

※ Other dimensions are the same for standard type.

ACP

APM

AS

**AX**

AM2

AM

AL  
ALX

AQ  
ADQ

AQ2  
ADQ2

AJ  
AJM

ABK

ACK1

NSK

AG

NGQ

AGX  
GX

NP

ADR

AMR

NDM

ARD

NST

AST

ASTH

NLCD

NLCS

# Series AX

## ② Adjustable Stroke Cylinder/Retraction Adjustable Type

AX (Mounting) (Type) (Bore Size) (Stroke) (Additional Symbol) (Stroke Adjusting Symbol) — XC9

**Additional symbol** ●  
 Blank-Without Boot  
 J-With Boot(Nylon tarpaulin)  
 K-With Boot(Neoprene cloth)

**Stroke Adjusting Symbol**  
 A-Stroke Adjusting Range 0~25mm  
 B-Stroke Adjusting Range 0~50mm

The Retracted Stroke of the cylinder can be adjusted from (0~25)mm or (0~50)mm by the adjusting bolt

### Symbol

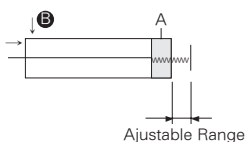

### Specifications

Fluid	Air
Proof Pressure	1.5MPa (213psi)
Max. Operating Pressure	1.0MPa (140psi)
Min. Operating Pressure	0.05MPa (7psi)
Piston Speed	50~750mm/sec
Cushion	Rubber cushion(Standard)
Stroke Adjusting System	Stopper adjustment
Stroke Adjusting Range	A : 0~25mm, B : 0~50mm
Mounting	Basic Type, Axial Foot Type, Rod Side Flange Type, Head Side Flange Type, Rod Side Trunnion Type, Head Side Trunnion Type
Applicable Bore Size(mm)	φ 20, φ 25, φ 32, φ 40
Stroke Range	~300 mm

### Construction, Dimensions/Basic Type

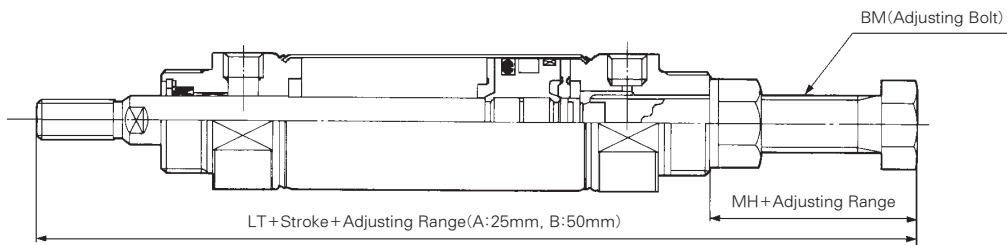

(Unit : mm)

Bore Size	BM	MH	LT
φ 20	M8×1.25	20	136
φ 25	M8×1.25	20	140
φ 32	M8×1.25	20	142
φ 40	M12×1.75	24	178

※ Other dimensions are the same for standard type.

## ③ Dual Stroke Cylinder/Double Rod Type

AX (Mounting Type) (Bore Size) (Stroke A) (Additional Symbol) + (Stroke B) (Additional Symbol) - XC10

Additional symbol ●

Blank-With Boot

J-With Boot(Nylon tarpaulin)

K-With Boot(Neoprene cloth)

Two cylinders are constructed as one cylinder in a back-to-back configuration allowing the cylinder stroke to be controlled in three steps.

### Symbol

Function

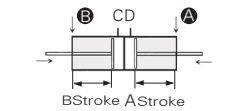

When air pressure is supplied to ports ① and ②, both A and B strokes retract.

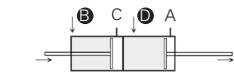

When air pressure is supplied to ports ③ and ④, A stroke extends.

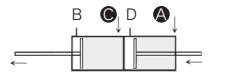

When air pressure is supplied to ports ① and ③, B stroke extends.

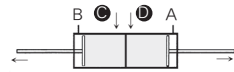

When air pressure is supplied to ports ③ and ④, both strokes A and B out strokes.

### Specifications

Type	Non-lube
Fluid	Air
Proof Pressure	1.5MPa (213psi)
Max. Operating Pressure	1.0MPa (140psi)
Min. Operating Pressure	0.05MPa (7psi)
Piston Speed	50~750 mm/sec
Cushion	Rubber cushion(Standard)
Mounting	Basic type, Foot type, Flange type
Applicable Bore Size(mm)	φ 20, φ 25, φ 32, φ 40
Stroke A, B	~300 mm

### Construction, Dimensions/Basic Type

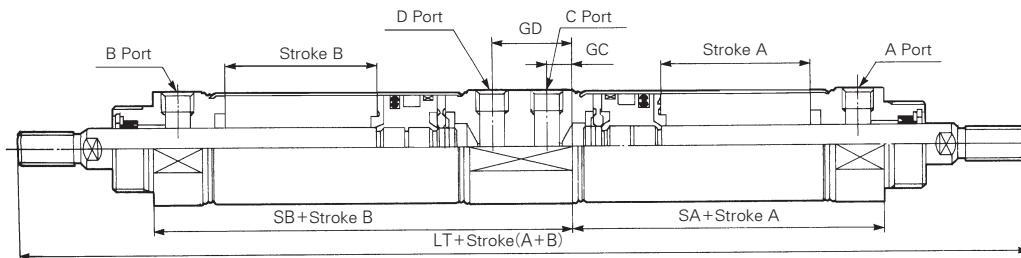

(Unit : mm)

Bore Size	GC	GD	SA	SB	LT
φ 20	7	24	47	78	207
φ 25	7	24	47	78	215
φ 32	7	24	49	80	219
φ 40	10.5	33.5	66.5	110.5	277

※ Other dimensions are the same for standard type.

ACP

APM

AS

**AX**

AM2

AM

AL  
ALX

AQ  
ADQ

AQ2  
ADQ2

AJ  
AJM

ABK

ACK1

NSK

AG

NGQ

AGX  
GX

NP

ADR

AMR

NDM

ARD

NST

AST

ASTH

NLCD

NLCS

# Series AX

## ④ Dual Stroke Cylinder/Single Rod Type

AX (Mounting) (Type) (Bore Size) (Stroke A) + (Stroke B - A) (Additional Symbol) -XC11

### Additional Symbol ●

Blank-With Boot

J-With Boot(Nylon tarpaulin)

K-With Boot(Neoprene cloth)

### Symbol

Function

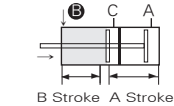

When air pressure is supplied to the B port, both A and B strokes retract.

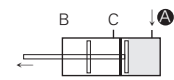

When air pressure is supplied to the A port, the rod extends by A Stroke.

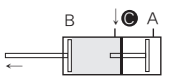

When air pressure is supplied to the C port, the rod extends.

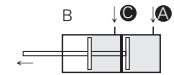

When air pressure is supplied to both ports A and C double output force is obtainable in the range of the A stroke length.

### Specifications

Fluid	Air
Proof Pressure	1.5MPa (213psi)
Max. Operating Pressure	1.0MPa (140psi)
Min. Operating Pressure	0.05MPa (7psi)
Piston Speed	50~750 mm/sec
Cushion	Rubber Cushion (Standard)
Mounting	Basic Type, Foot Type, Rod Side Flange Type, Head Side Flange type, Single Clevis Type, Double Clevis Type.
Applicable Bore Size(mm)	φ 20, φ 25, φ 32, φ 40
Stroke	~300 mm

### Construction, Dimensions/Basic Type

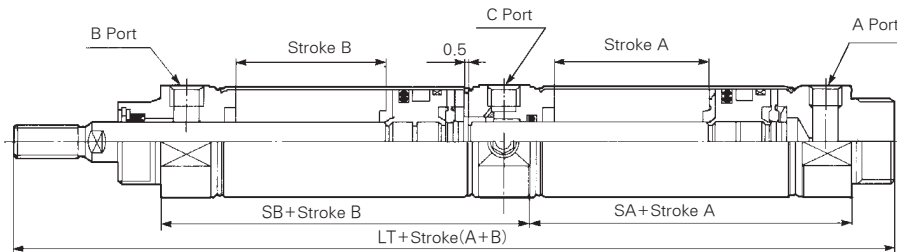

(Unit : mm)

Bore Size	SA	SB	LT
φ 20	48	62	164
φ 25	48	62	168
φ 32	50	64	172
φ 40	67.5	88.5	222

※ Other dimensions are the same for standard type.

⑤ Tandem Type Air Cylinder

AX **Mounting** **Type** **Bore Size** **Stroke** -XC12

This is a cylinder produced with two air cylinders in line allowing double the output force.

Symbol

Function

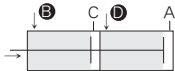

When air pressure is supplied to ports ③ and ④, the output force is doubled in the retract stroke.

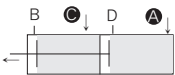

When air pressure is supplied to ports ① and ②, the output force is doubled in the extend stroke.

Specifications

Type	Air cylinder
Applicable Bore Size	φ 20, φ 25, φ 32, φ 40
Max. Operating Pressure	1.0 MPa (140psi)
Min. Operating Pressure	0.08 MPa (11psi)
Cushion	Rubber Cushion (Standard)
Action	Double Acting
Mounting	Basic Type, Axial Foot Type, Rod Side Flange Type, Head Side Flange Type, Single Clevis Type, Double Clevis Type

Construction Dimension

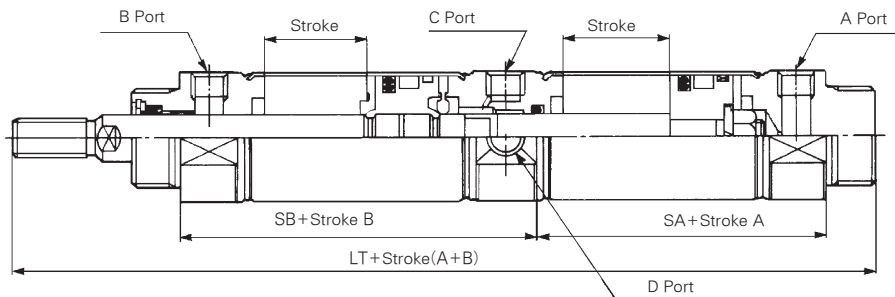

(Unit : mm)

Bore Size	SA	SB	LT
φ 20	48	62	164
φ 25	48	62	168
φ 32	50	64	172
φ 40	67.5	88.5	222

※ Other dimensions are the same for standard type.

- ACP
- APM
- AS
- AX**
- AM2
- AM
- AL
- ALX
- AQ
- ADQ
- AQ2
- ADQ2
- AJ
- AJM
- ABK
- ACK1
- NSK
- AG
- NGQ
- AGX
- GX
- NP
- ADR
- AMR
- NDM
- ARD
- NST
- AST
- ASTH
- NLCD
- NLCS

# Series AXW

## Standard Type/Double Acting : Double Rod

Bore Size(mm) :  $\varnothing 20$ ,  $\varnothing 25$ ,  $\varnothing 32$ ,  $\varnothing 40$



- STAINLESS STEEL BODY
- HIGH CYCLE LIFE
- LOW BREAKAWAY
- NUMEROUS MOUNTING OPTION
- MAGNET STANDARD FOR AUTO SWITCH
- BUMPERS STANDARD (AIR CUSHION OPTIONAL)
- DESIGNED FOR NON-LUBRICATED SERVICE
- COMPACT LIGHT DESIGN
- REPLACEABLE ROD GLAND

Symbol Double Acting/Double Rod

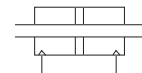

### How to Order

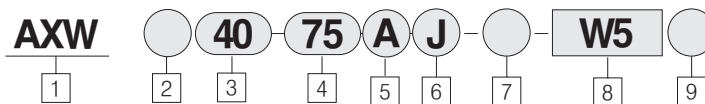

**1 Double Rod Type**  
(Built-in Magnet Standard)

**2 Mounting**  
B : Basic Type  
L : Foot Type  
F : Flange Type  
U : Trunnion Type

**3 Bore Size(mm)**  
20 :  $\varnothing 20$   
25 :  $\varnothing 25$   
32 :  $\varnothing 32$   
40 :  $\varnothing 40$

**4 Stroke(mm)**  
 $\varnothing 20$  : 25, 50, 75, 100, 125, 150, 200, 250, 300  
 $\varnothing 25$  : 25, 50, 75, 100, 125, 150, 200, 250, 300  
 $\varnothing 32$  : 25, 50, 75, 100, 125, 150, 200, 250, 300  
 $\varnothing 40$  : 25, 50, 75, 100, 125, 150, 200, 250, 300

**5 Cushion**  
Blank : Rubber Cushion  
A : Air Cushion

**6 Rod Boot Option**  
Blank : None  
J : Nylon Tarpaulin(Single side)  
JJ : Nylon Tarpaulin(Both side)  
K : Neoprene Cloth(Single side)  
KK : Neoprene Cloth(Both side)

**7 Special Option**  
Blank : Standard type  
XC16 : Copper-free

**8 Auto Switch**  
(Band mounted type)  
[Grommet]  
Blank : None  
W5 : W5  
W5L : Reed Switch, 3m Lead wire

**9 Number of Auto Switches**  
Blank : 2 pcs  
S : 1 pc  
N : N pcs

PART No. of Mounting Bracket				
Bore Size(mm)	$\varnothing 20$	$\varnothing 25$	$\varnothing 32$	$\varnothing 40$
*Axial foot	TCM-L020B	TCM-L032B	TCM-L040B	
Flange	TCM-F020B	TCM-F032B	TCM-F040B	
Trunnion(With Nut)	TCM-T020B	TCM-T032B	TCM-T040B	

\* 2pcs. Required Per Cylinder

PART No. of Auto Mounting Band				
Auto Switch Model	Bore Size(mm)			
	$\varnothing 20$	$\varnothing 25$	$\varnothing 32$	$\varnothing 40$
W5	TBM2-020	TBM2-025	TBM2-032	TBM2-040

## Series AXW

Model				
Bore size(mm)	φ 20	φ 25	φ 32	φ 40
Type	Air Cylinder			
Cushion	Rubber Cushion, Air Cushion			
Piping Method	1/8 Rc(PT)	1/8 Rc(PT)	1/8 Rc(PT)	1/4 Rc(PT)
Magnet	Built-in Magnet Standard			
Auto Switch (Band Mounted Type)	Reed Auto Switch /w5			
Boot	• None • Nylon Tarpanlin(60℃) • Neoprene cloth			

Standard Stroke List	
Action	Double Acting Double Rod
Fluid	Air
Proof Pressure	1.5 MPa (213psi)
Max. Operating Pressure	1.0 MPa (140psi)
Min. Operating Pressure	0.05 MPa (7psi)
Ambient and Fluid Temperature	-10~+70℃ (14~158°F)
Lubrication	None (Non-Lube)
Thread Tolerance	KS 2 Class
Stroke Tolerance	$^{+1.4}_0$ mm

Piston Speed				
Bore Size(mm)	φ 20	φ 25	φ 32	φ 40
Piston Speed(mm/sec)	50~750			
Allowable Kinetic Energy(kgf/cm)	2.7	4	6.5	12

Auto Switch Specifications		
Mounting	Lead Wire Entry	Reed Switch
Band Mounted Type	Grommet	W5

\* A long stroke applies to the foot type and the flange type. For other mountings and case exceeding the Standard stroke limit, the max.

- ACP
- APM
- AS
- AX**
- AM2
- AM
- AL  
ALX
- AQ  
ADQ
- AQ2  
ADQ2
- AJ  
AJM
- ABK
- ACK1
- NSK
- AG
- NGQ
- AGX  
GX
- NP
- ADR
- AMR
- NDM
- ARD
- NST
- AST
- ASTH
- NLCD
- NLCS

# Series AXW

## Mounting and Accessories

Accessories	Standard		Option		
	Mounting Nut	Rod end Nut	Single Knuckle Joint	Double Knuckle Joint	Rod Boot
Basic Type	○ (2pcs)	○ (2pcs)	○	○	○
Foot Type	○ (2pcs)	○ (2pcs)	○	○	○
Flange Type	○ (1pc)	○ (2pcs)	○	○	○
Trunnion Type	○ (1pc)	○ (2pcs)	○	○	○
Note				With pin	Single, Both side

## Material of Gaiter

Symbol		Material of Boot	Max. Ambient Temperature
Single Side	Both Side		
J	JJ	Nylon tarpaulin	140°F(60°C)
K	KK	Neoprene cloth	※230°F(110°C)

※ The max. ambient temperature of Boot only.

## Weight Table

Bore Size(mm)		kgf(lbf)			
		φ 20	φ 25	φ 32	φ 40
Basic Weight	Basic Type	0.16(0.35)	0.25(0.55)	0.33(0.71)	0.65(1.43)
	Foot Type	0.31(0.68)	0.42(0.90)	0.48(1.06)	0.92(1.06)
	Flange Type	0.22(0.49)	0.34(0.75)	0.41(0.90)	0.77(1.70)
	Trunnion Type	0.20(0.44)	0.33(0.71)	0.38(0.84)	0.75(1.65)
Additional weight for each 50 of stroke		0.06(0.43)	0.09(0.20)	0.13(0.27)	0.19(0.42)
Mounting	Single Knuckle Joint	0.06(0.13)	0.07(0.13)	0.06(0.13)	0.23(0.51)
Bracket	Double Knuckle Joint(with pin)	0.07(0.15)	0.07(0.15)	0.07(0.15)	0.21(0.44)

### Calculation (Example) AXWL32-100

- Basic weight-1.06(Foot type, φ 32)
- Additional weight-0.29/50 stroke
- Cylinder stroke -100 stroke
- $1.06 + 0.29 \times 100 / 50 = 1.64 \text{ lbf}$

## With Air Cushion

AXW (Mounting) (Bore Size) (Piping Method) — Stroke A (Boot)

With Air Cushion

With covers on both sides equipped with the cushion function, the cylinder absorbs the impact during high-speed operation without vibrating the section around it, and the cylinder provides longer life.

### Specifications

Action	Double acting double rod
Bore Size	φ 20, φ 25, φ 32, φ 40
Max. Operating Pressure	1.0MPa(140Psi)
Min. Operating Pressure	0.05MPa(7.1Psi)
Cushion	Air Cushion
Piping Method	Screwed Type
Piston Speed	50~1,000mm/sec
Mounting	Basic Type, Foot Type, Flange Type, Trunnion Type

※Auto switch Available

### Cushion Mechanism

Bore Size (mm)	Effective Cushion Length mm(inch)	Cushion Effective orifice cm <sup>2</sup> (in <sup>2</sup> )	Allowable Kinetic Energy kgf-cm(lbs-in)
φ 20	11.0(0.433)	2.09(0.324)	5.5(4.774)
φ 25	11.0(0.433)	3.30(0.512)	8.0(6.944)
φ 32	11.0(0.433)	5.86(0.908)	13(11.287)
φ 40	11.8(0.465)	9.08(1.407)	24(20.832)



Construction/Parts List

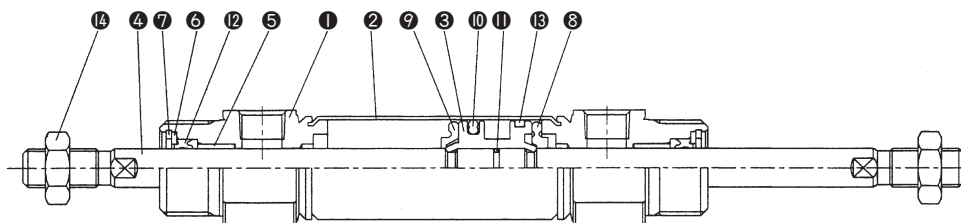

With Air Cushion

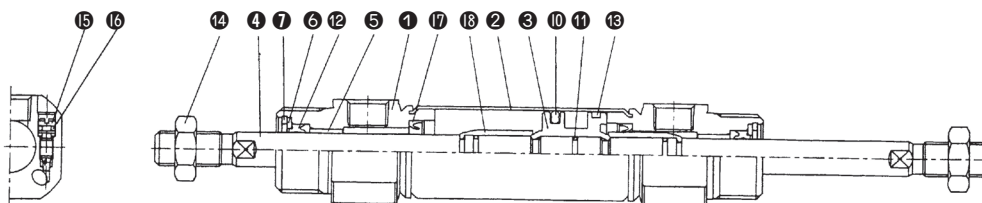

Parts List

No.	Description	Material	Note
1	Rod Cover	Aluminum Alloy	White Alumite
2	Cylinder Tube	Stainless Steel	
3	Piston	Aluminum Alloy	Chromate
4	Piston Rod	Carbon Steel	Hard Chrome Plated
5	Bush	Sintered Metal	
6	Packing Retainer	Rolled Steel	Nickel Plated
7	Stopper Ring	Carbon Steel	Nickel Plated
8	Damper A	Urethane	
9	Damper B	Urethane	
10	Piston Packing	NBR	
11	Piston Gasket	NBR	
13	Wear Ring	-	

No.	Description	Material	Note
14	Rod End Nut	-	Nickel Plated
15	Cushion Valve	-	Nickel Plated
16	Cushion Valve Gasket	NBR	
17	Cushion Packing	NBR	
18	Cushion Ring	-	

Spare Parts/Packing List

Rubber Cushion / Air Cushion

No.	Description	Material	Type	Bore Size			
				20	25	32	40
12	Rod Packing	NBR	Rubber Cushion	PDU-8LZ	PDU-10LZ	PDU-12LZ	PDU-14LZ
			Air Cushion	PDU-8Z	PDU-10Z	PDU-12Z	PDU-14Z

- ACP
- APM
- AS
- AX**
- AM2
- AM
- AL
- ALX
- AQ
- ADQ
- AQ2
- ADQ2
- AJ
- AJM
- ABK
- ACK1
- NSK
- AG
- NGQ
- AGX
- GX
- NP
- ADR
- AMR
- NDM
- ARD
- NST
- AST
- ASTH
- NLCD
- NLCS

# Series AXW

## Basic Type(B)

AXWB Bore Size Stroke

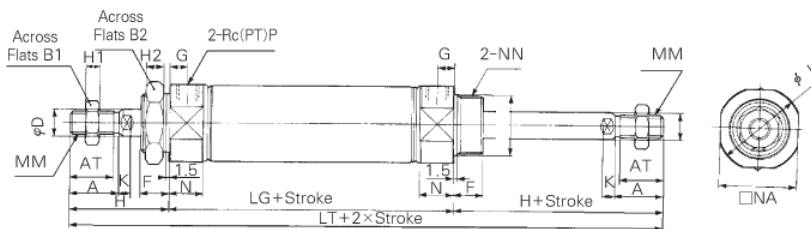

### With Rod Boot(Both side)

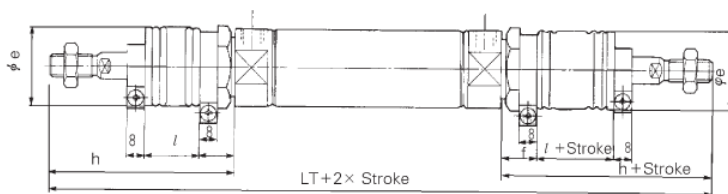

### With Air Cushion

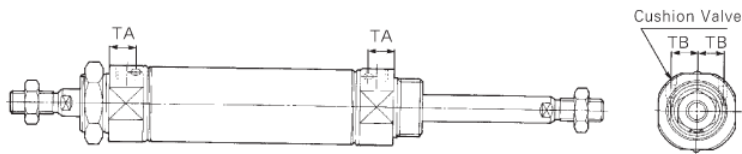

※ 301mm Stroke or more : Long Stroke

(Unit : mm)

Bore Size	Stroke Range	A	AT	B <sub>1</sub>	B <sub>2</sub>	D	E	F	G	H	H <sub>1</sub>	H <sub>2</sub>	I	K	MM	N	NA	NN	P	LG	LT
φ 20	~300	18	15.5	13	26	8	20 <sup>0</sup> <sub>-0.033</sub>	13	8	41	5	8	27	5	M8×1.25	15	24	M20×1.5	1/8	62	144
φ 25	~300	22	19.5	17	32	10	26 <sup>0</sup> <sub>-0.033</sub>	13	8	45	6	8	33	5.5	M10×1.25	15	30	M26×1.5	1/8	62	152
φ 32	~300	22	19.5	17	32	12	26 <sup>0</sup> <sub>-0.033</sub>	13	8	45	6	8	37.5	5.5	M10×1.25	15	34.5	M26×1.5	1/8	64	154
φ 40	~300	24	21	22	41	14	32 <sup>0</sup> <sub>-0.039</sub>	16	11	50	8	10	46.5	7	M14×1.5	21.5	42.5	M32×2	1/4	88	188

### With Gaiter

Bore Size	e	f	h							l							LT						
			1~50	51~100	101~150	151~200	201~300	301~400	401~500	1~50	51~100	101~150	151~200	201~300	301~400	401~500	1~50	51~100	101~150	151~200	201~300	301~400	401~500
φ 20	30	16	68	81	93	106	131	156	—	12.5	25	37.5	50	75	100	—	198	224	248	274	324	374	—
φ 25	30	16	72	85	97	110	135	160	185	12.5	25	37.5	50	75	100	125	206	232	256	282	332	382	432
φ 32	30	16	72	85	97	110	135	160	185	12.5	25	37.5	50	75	100	125	208	234	258	284	334	384	434
φ 40	40	18	77	90	102	115	140	165	190	12.5	25	37.5	50	75	100	125	242	268	292	318	368	418	468

### With Air Cushion

Bore size	TA	TB
φ 20	11.5	8.5
φ 25	11.5	10
φ 32	11.5	11.5
φ 40	14.5	15

Axial Foot Type(L)

AXWL Bore Size Stroke

Standard

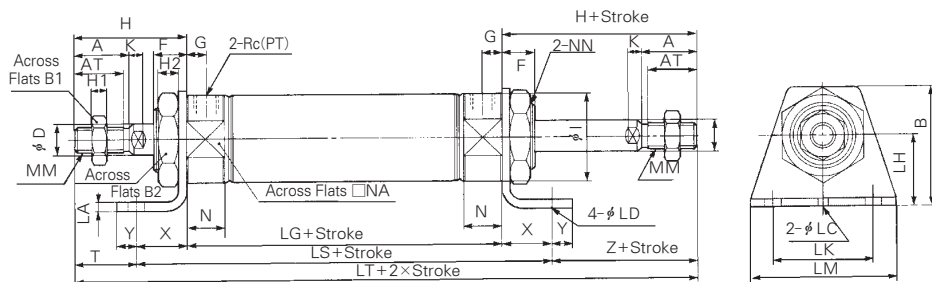

With Air Cushion

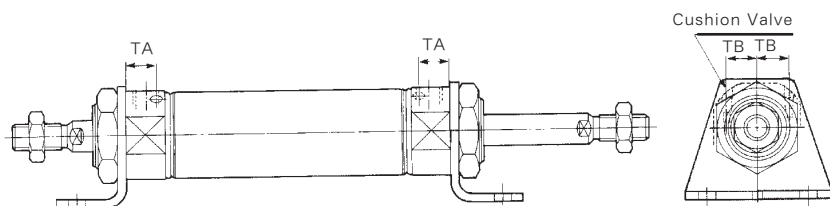

(Unit : mm)

Bore Size	Stroke Range	A	AT	B	B1	B2	D	F	G	H	H1	H2	I	K	LC	LD	LH	LS	LA	LK	LM	MM	N	NA	NN	P	LG	X	Y	T	LT
φ 20	~400	18	15.5	40	13	26	8	13	8	41	5	8	27	5	4	6.8	25	102	3.2	40	55	M8×1.25	15	24	M20×1.5	1/8	62	20	8	21	144
φ 25	~450	22	19.5	47	17	32	10	13	8	45	6	8	33	5.5	4	6.8	28	102	3.2	40	55	M10×1.25	15	30	M26×1.5	1/8	62	20	8	25	152
φ 32	~450	22	19.5	47	17	32	12	13	8	45	6	8	37.5	5.5	4	6.8	28	104	3.2	40	55	M10×1.25	15	34.5	M26×1.5	1/8	64	20	8	25	154
φ 40	~500	24	21	54	22	41	14	16	11	50	8	10	46.5	7	4	7	30	134	3.2	55	75	M14×1.5	21.5	42.5	M32×2	1/4	88	23	10	27	188

With Air Cushion

Bore size	TA	TB
φ 20	11.5	8.5
φ 25	11.5	10
φ 32	11.5	11.5
φ 40	14.5	15

- ACP
- APM
- AS
- AX**
- AM2
- AM
- AL
- ALX
- AQ
- ADQ
- AQ2
- ADQ2
- AJ
- AJM
- ABK
- ACK1
- NSK
- AG
- NGQ
- AGX
- GX
- NP
- ADR
- AMR
- NDM
- ARD
- NST
- AST
- ASTH
- NLCD
- NLCS

# Series AXW

## Flange Type(F)

AXWF Bore Size Stroke  

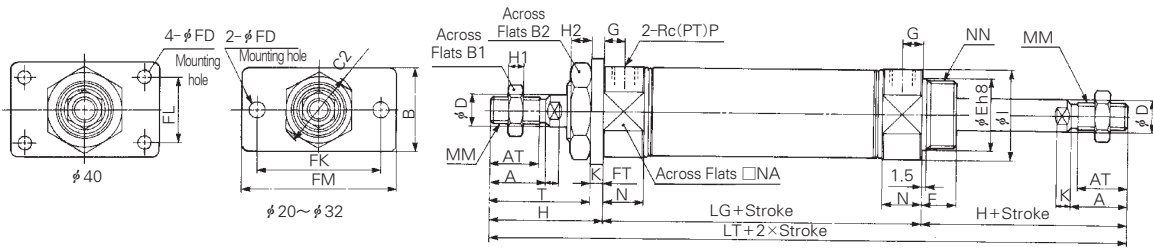

## With Air Cushion

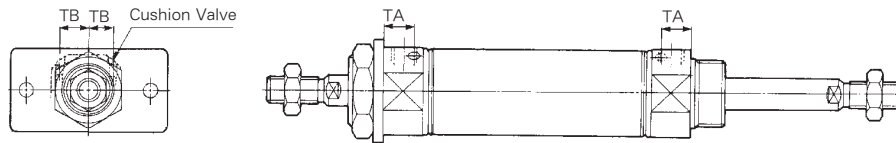

(Unit : mm)

Bore Size	Stroke Range	A	AT	B	B <sub>1</sub>	B <sub>2</sub>	C <sub>2</sub>	D	E	F	FD	FT	FK	FL	FM	G	H	H <sub>1</sub>	H <sub>2</sub>	I	K	MM
$\phi 20$	~300	18	15.5	34	13	26	30	8	20 <sup>0</sup> <sub>-0.033</sub>	13	7	4	60	—	75	8	41	5	8	27	5	M8×1.25
$\phi 25$	~300	22	19.5	40	17	32	37	10	26 <sup>0</sup> <sub>-0.033</sub>	13	7	4	60	—	75	8	45	6	8	33	5.5	M10×1.25
$\phi 32$	~300	22	19.5	40	17	32	37	12	26 <sup>0</sup> <sub>-0.033</sub>	13	7	4	60	—	75	8	45	6	8	37.5	5.5	M10×1.25
$\phi 40$	~300	24	21	52	22	41	47.3	14	32 <sup>0</sup> <sub>-0.039</sub>	16	7	5	66	36	82	11	50	8	10	46.5	7	M14×1.5

(Unit : mm)

Bore Size	N	NA	NN	P	LG	T	LT
$\phi 20$	15	24	M20×1.5	1/8	62	37	144
$\phi 25$	15	30	M26×1.5	1/8	62	41	152
$\phi 32$	15	34.5	M26×1.5	1/8	64	41	154
$\phi 40$	21.5	42.5	M32×2	1/4	88	45	188

## With Air Cushion

Bore size	TA	TB
$\phi 20$	11.5	8.5
$\phi 25$	11.5	10
$\phi 32$	11.5	11.5
$\phi 40$	14.5	15

# Series AXW

## Trunnion Type(U)

AXWU Bore Size Stroke

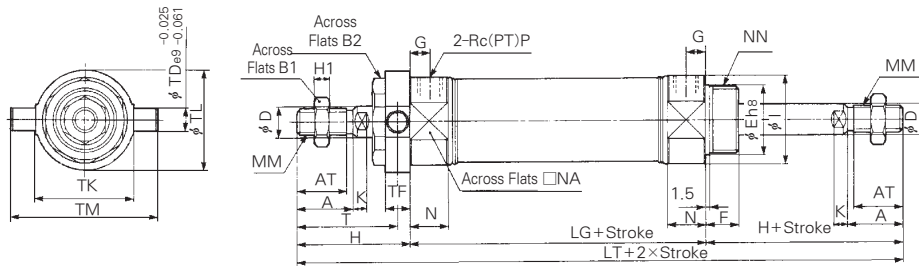

### With Air Cushion

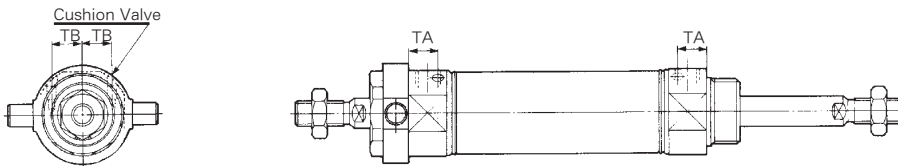

(Unit : mm)

Bore Size	Stroke Range	A	AT	B <sub>1</sub>	B <sub>2</sub>	D	E	F	G	H	H <sub>1</sub>	I	K	MM	N	NA	NN	P	LG
φ20	~300	18	15.5	13	26	8	20 <sup>0</sup> <sub>-0.033</sub>	13	8	41	5	27	5	M8×1.25	15	24	M20×1.5	1/8	62
φ25	~300	22	19.5	17	32	10	26 <sup>0</sup> <sub>-0.033</sub>	13	8	45	6	33	5.5	M10×1.25	15	30	M26×1.5	1/8	62
φ32	~300	22	19.5	17	32	12	26 <sup>0</sup> <sub>-0.033</sub>	13	8	45	6	37.5	5.5	M10×1.25	15	34.5	M26×1.5	1/8	64
φ40	~300	24	21	22	41	14	32 <sup>0</sup> <sub>-0.039</sub>	16	11	50	8	46.5	7	M14×1.5	21.5	42.5	M32×2	1/4	88

(Unit : mm)

Bore Size	TD	TF	TK	TL	TM	T	LT
φ20	8	10	32	32	52	36	144
φ25	9	10	40	40	60	40	152
φ32	9	10	40	40	60	40	154
φ40	10	11	53	53	77	44.5	188

### With Air Cushion

Bore Size	TA	TB
φ20	11.5	8.5
φ25	11.5	10
φ32	11.5	11.5
φ40	14.5	15

- ACP
- APM
- AS
- AX
- AM2
- AM
- AL  
ALX
- AQ  
ADQ
- AQ2  
ADQ2
- AJ  
AJM
- ABK
- ACK1
- NSK
- AG
- NGQ
- AGX  
GX
- NP
- ADR
- AMR
- NDM
- ARD
- NST
- AST
- ASTH
- NLCD
- NLCS

# Series **AXS**

## Standard Type/Single Acting:Spring Return, Spring Extended

Bore Size(mm) :  $\phi 20$ ,  $\phi 25$ ,  $\phi 30$ ,  $\phi 40$



- STAINLESS STEEL BODY
- HIGH CYCLE LIFE
- LOW BREAKAWAY
- NUMEROUS MOUNTING OPTION
- MAGNET STANDARD FOR AUTO SWITCH
- BUMPERS STANDARD
- DESIGNED FOR NON-LUBRICATED SERVICE
- COMPACT LIGHT DESIGN
- REPLACEABLE ROD GLAND

### Symbol

Single acting spring return

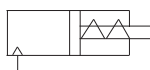

Single acting spring Extended



## How to Order

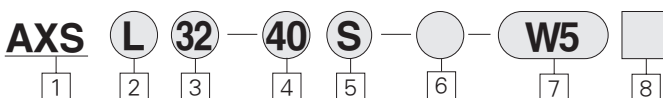

### 1 Type:Single Acting

※ (Built-in Magnet Standard)

### 2 Mounting

- B : Basic Type
- L : Axial Foot Type
- F : Rod Side Flange Type
- G : Head Side Flange Type
- C : Single Clevis Type
- D : Double Clevis Type
- T : Head Side Trunnion Type
- U : Rod Side Trunnion Type
- E : Integrated Clevis Type
- BZ : Boss-Cut Basic Type
- FZ : Boss-Cut Flange Type
- UZ : Boss-Cut Trunnion Type

### 3 Bore Size(mm)

- 20 :  $\phi 20$
- 25 :  $\phi 25$
- 32 :  $\phi 32$
- 40 :  $\phi 40$

### 4 Stroke

- $\phi 20$  : 25, 50, 75, 100, 125, 150

- $\phi 25$  : 25, 50, 75, 100, 125, 150
- $\phi 32$  : 25, 50, 75, 100, 125, 150, 200
- $\phi 40$  : 25, 50, 75, 100, 125, 150, 200, 250

### 5 Action

- S : Single Acting Spring Return
- T : Single Acting Spring Extended

### 6 Special Option

- Blank : Standard type
- XC16 : Copper-free

### 7 Auto Switch

- Blank : None
- W5 : Reed Switch, 0.5m Lead Wire
- W5L : Reed Switch, 3m Lead wire

### 8 Number of Auto Switches

- Blank : 2 pcs
- S : 1 pc
- N : N pcs

### PART No. of Mounting Bracket

Bore Size(mm)	$\phi 20$	$\phi 25$	$\phi 32$	$\phi 40$
※ Axial foot	TCM-L020B	TCM-L032B	TCM-L040B	
Flange	TCM-F020B	TCM-F032B	TCM-F040B	
Single Clevis	TCM-C020B	TCM-C032B	TCM-C040B	
Double Clevis	TCM-D020B	TCM-D032B	TCM-D040B	
Trunnion(With Nut)	TCM-T020B	TCM-T032B	TCM-T040B	

※ 2pcs. Required Per Cylinder

### PART No. of Auto Switch Mounting Band

Auto Switch Model	Bore Size(mm)			
	$\phi 20$	$\phi 25$	$\phi 32$	$\phi 40$
W5	TBM2-020	TBM2-025	TBM2-032	TBM2-040

## Series AXS

Model				
Bore Size(mm)	φ 20	φ 25	φ 32	φ 40
Type	Air Cylinder			
Cushion	Rubber Cushion			
Piping Method	Rc(PT) 1/8	Rc(PT) 1/8	Rc(PT) 1/8	Rc(PT) 1/4
Magnet	Built-in Magnet Standard			
Auto Switch(Band Mounted Type)	Reed Auto Switch/W5			

Specifications		
Action	Spring Return	Spring Extended
Fluid	Air	
Proof Pressure	1.5MPa (213psi)	
Max. Operating Pressure	1.0MPa	
Min. Operating Pressure	0.18 MPa(25psi)	0.23 MPa(32psi)
Ambient and Fluid Temperature	-10~+70° C (14~158° F)	
Lubrication	Non-lube	
Thread Tolerance	KS 2 class	
Stroke Tolerance	+1.4 0 mm	

Piston Speed				
Bore Size(mm)	φ 20	φ 25	φ 32	φ 40
Piston speed(mm/sec)	50~750			
Allowable kinetic energy(kgf-cm)	2.7	4	6.5	12

Auto Switch Specification		
Mounting	Lead Wire Entry	Reed Switch
Band Mounting Type	Grommet	W5

### Boss-Cut Type

Boss for the head cover bracket is eliminated and the total length of the cylinder is shortened.

### Compared to the Total Length of Cylinder

(Compared to the Basic Type)

φ 20	φ 25	φ 32	φ 40
▼13	▼13	▼13	▼16

#### Mounting

- Boss-Cut Basic Type(BZ)
- Boss-Cut Flange Type(FZ)
- Boss-Cut Trunnion Type(UZ)

ACP
APM
AS
<b>AX</b>
AM2
AM
AL
ALX
AQ
ADQ
AQ2
ADQ2
AJ
AJM
ABK
ACK1
NSK
AG
NGQ
AGX
GX
NP
ADR
AMR
NDM
ARD
NST
AST
ASTH
NLCD
NLCS

# Series AXS

## Mounting and Accessories

Accessories Mounting	Standard			Option	
	Mounting Nut	Rod end Nut	Clevis Pin	Single Knuckle Joint	Double Knuckle Joint
Basic Type	○ 1pc.	○	—	○	○
Axial Foot Type	○ 2pcs.	○	—	○	○
Rod Side Flange Type	○ 1pc.	○	—	○	○
Head Side Flange Type	○ 1pc.	○	—	○	○
Integrated Clevis Type	—	○	—	○	○
Single Clevis Type	—	○	—	○	○
Double Clevis Type	—	○	○	○	○
Head Side Trunnion Type	○ 1pc.	○	—	○	○
Rod Side Trunnion Type	○ 1pc.	○	—	○	○
Boss-Cut Basic Type	○ 1pc.	○	—	○	○
Boss-Cut Flange Type	○ 1pc.	○	—	○	○
Boss-Cut Trunnion Type	○ 1pc.	○	—	○	○
Note					With Pin

## Weight Table

### Spring Return

kgf(lbf)

Bore Size (mm)		φ20	φ25	φ32	φ40
Basic weight	25 stroke	0.20(0.44)	0.31(0.66)	0.42(0.93)	0.77(1.70)
	50 stroke	0.22(0.49)	0.33(0.73)	0.46(1.01)	0.84(1.85)
	75 stroke	0.27(0.60)	0.42(0.93)	0.58(1.28)	1.03(2.27)
	100 stroke	0.29(0.64)	0.45(0.99)	0.63(1.39)	1.09(2.40)
	125 stroke	0.35(0.77)	0.55(1.19)	0.76(1.08)	1.29(2.84)
	150 stroke	0.37(0.81)	0.57(1.26)	0.81(1.76)	1.36(3.0)
	200 stroke	—	—	0.97(2.14)	1.61(3.55)
	250 stroke	—	—	—	1.87(4.12)
Mounting Bracket Weight	Foot Type	0.15(0.33)	0.16(0.35)	0.16(0.35)	0.27(0.60)
	Flange Type	0.06(0.13)	0.09(0.20)	0.09(0.20)	0.12(0.26)
	Single Clevis Type	0.05(0.09)	0.05(0.09)	0.05(0.09)	0.09(0.20)
	Double Clevis Type	0.05(0.11)	0.06(0.13)	0.06(0.13)	0.13(0.28)
	Trunnion Type	0.04(0.09)	0.07(0.15)	0.07(0.15)	0.10(0.22)
	Integrated Clevis Type	-0.02(-0.04)	-0.02(-0.04)	-0.01(-0.02)	-0.04(-0.09)
	Boss-Cut Basic Type	-0.01(-0.02)	-0.02(-0.04)	-0.02(-0.04)	-0.03(0.07)
	Boss-Cut Flange Type	0.05(0.11)	0.08(0.15)	0.08(0.15)	0.09(0.20)
Accessories	Single Knuckle Joint	0.06(0.13)	0.06(0.13)	0.06(0.13)	0.23(0.51)
	Double Knuckle Joint(with pin)	0.08(0.15)	0.08(0.15)	0.08(0.15)	0.20(0.44)

### Spring Extended

kgf(lbf)

Bore Size(mm)		φ20	φ25	φ32	φ40
Basic weight	25 stroke	0.19(0.42)	0.29(0.64)	0.40(0.88)	0.74(1.63)
	50 stroke	0.21(0.46)	0.32(0.71)	0.44(0.97)	0.81(1.76)
	75 stroke	0.26(0.55)	0.39(0.86)	0.54(1.19)	0.97(2.14)
	100 stroke	0.27(0.60)	0.42(0.93)	0.58(1.28)	1.03(2.27)
	125 stroke	0.32(0.71)	0.49(1.08)	0.70(1.52)	1.20(2.65)
	150 stroke	0.34(0.75)	0.52(1.15)	0.73(1.61)	1.27(2.80)
	200 stroke	—	—	0.88(1.94)	1.49(3.28)
	250 stroke	—	—	—	1.72(3.79)
Mounting Bracket Weight	Foot Type	0.15(0.33)	0.16(0.35)	0.16(0.35)	0.27(0.60)
	Flange Type	0.06(0.13)	0.1(0.20)	0.1(0.20)	0.12(0.26)
	Single Clevis Type	0.04(0.09)	0.04(0.09)	0.04(0.09)	0.09(0.20)
	Double Clevis Type	0.05(0.09)	0.07(0.13)	0.07(0.13)	0.13(0.29)
	Trunnion Type	0.04(0.09)	0.07(0.15)	0.07(0.15)	0.10(0.22)
	Integrated Clevis Type	-0.02(-0.04)	-0.03(-0.04)	-0.01(-0.02)	-0.04(-0.09)
	Boss-Cut Basic Type	-0.01(-0.02)	-0.03(-0.04)	-0.02(-0.04)	-0.03(0.07)
	Boss-Cut Flange Type	0.05(0.11)	0.08(0.15)	0.08(0.15)	0.09(0.20)
Accessories	Single Knuckle Joint	0.07(0.13)	0.07(0.13)	0.07(0.13)	0.23(0.51)
	Double Knuckle Joint(with pin)	0.07(0.15)	0.07(0.15)	0.07(0.15)	0.20(0.44)

### Calculation Example : AXL32-100S

Basic weight ...1.39lbf(Foot type φ32)

Cylinder stroke ...100 stroke

1.39+0.35=1.74lbf



## Construction/Parts List

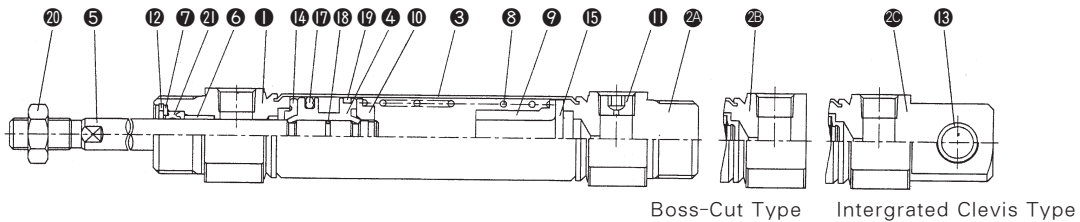
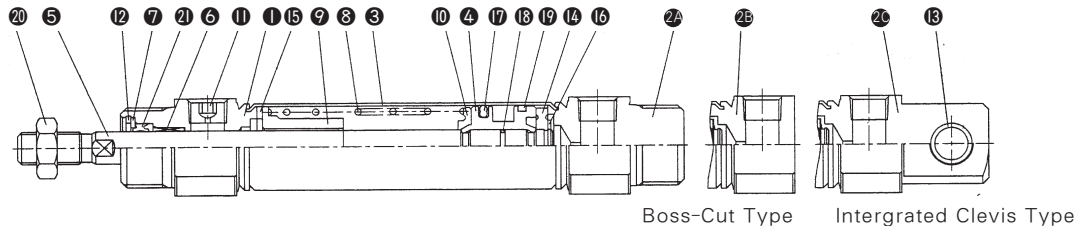

### Part List

No.	Description	Material	Remarks
1	Rod Cover	Aluminum Alloy	White Alumite
2A	Head Cover-A	Aluminum Alloy	White Alumite
2B	Head Cover-B	Aluminum Alloy	White Alumite
2C	Head Cover-C	Aluminum Alloy	White Alumite
3	Cylinder Tube	Stainless Steel	-
4	Piston	Aluminum Alloy	Chromate
5	Piston Rod	Carbon Steel	Hard Chrome Plated
6	Guide Bush	Sintered Metal	
7	Retaining Ring	Rolled steel	Nickel Plated
8	Spring	Steel Wire	Zinc chromate
9	Spring Guide	Aluminum Alloy	Chromate
10	Spring Supporter	Aluminum Alloy	"
11	Plug	Alloy Steel	Black Chromate
12	Stopper Ring	Carbon Tool Steel	Nickel Plated
13	Bushing	Sintered Metal	

No.	Description	Material	Remarks
14	Damper A	Urethane	
15	Damper B	Urethane	
16	Retaining Ring	Carbon Tool Steel	
17	Piston Packing	NBR	
18	Piston Gasket	NBR	
19	Wear Ring	Resin	
20	Rod End Nut	Carbon Steel	Nickel Plated

### Packing List

#### Rubber Cushion / Air Cushion

No.	Description	Material	Type	Bore Size			
				20	25	32	40
1	Rod Packing	NBR	Rubber Cushion	PDU-8LZ	PDU-10LZ	PDU-12LZ	PDU-14LZ
			Air Cushion	PDU-8Z	PDU-10Z	PDU-12Z	PDU-14Z

ACP

APM

AS

**AX**

AM2

AM

AL  
ALXAQ  
ADQAQ2  
ADQ2AJ  
AJM

ABK

ACK1

NSK

AG

NGQ

AGX  
GX

NP

ADR

AMR

NDM

ARD

NST

AST

ASTH

NLCD

NLCS

# Series AXS

## Basic(B)

AXB Bore Size Stroke S

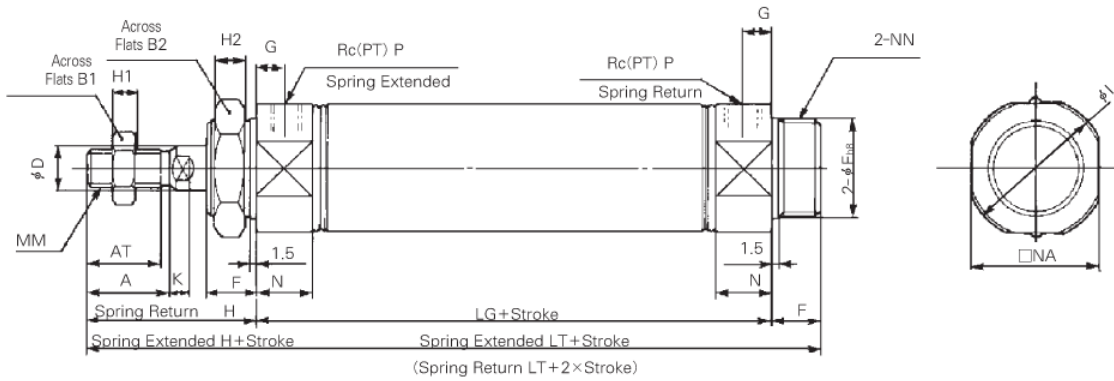

### Boss-Cut Type

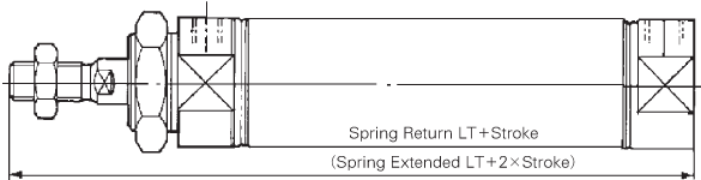

\* This Drawing is Spring Extended.

(Unit : mm)

Bore Size	A	AT	B <sub>1</sub>	B <sub>2</sub>	D	E	F	G	H	H <sub>1</sub>	H <sub>2</sub>	I	K	MM	N	NA	NN	P
φ20	18	15.5	13	26	8 <sup>-0.01/-0.05</sup>	20 <sup>0/-0.033</sup>	13	8	41	5	8	27	5	M8×1.25	15	24	M20×1.5	1/8
φ25	22	19.5	17	32	10 <sup>-0.01/-0.05</sup>	26 <sup>0/-0.033</sup>	13	8	45	6	8	33	5.5	M10×1.25	15	30	M26×1.5	1/8
φ32	22	19.5	17	32	12 <sup>-0.01/-0.05</sup>	26 <sup>0/-0.033</sup>	13	8	45	6	8	37.5	5.5	M10×1.25	15	34.5	M26×1.5	1/8
φ40	24	21	22	41	14 <sup>-0.01/-0.05</sup>	32 <sup>0/-0.039</sup>	16	11	50	8	10	46.5	7	M14×1.5	21.5	42.5	M32×2	1/4

### Stroke Dimension Adder

(Unit : mm)

Stroke Symbol	1~50		51~100		101~150		151~200		201~250	
	LG	LT	LG	LT	LG	LT	LG	LT	LG	LT
φ20	87	141	112	166	137	191	—	—	—	—
φ25	87	145	112	170	137	195	—	—	—	—
φ32	89	147	114	172	139	197	164	222	—	—
φ40	113	179	138	204	163	229	188	254	213	279

### Boss-Cut Type

(Unit : mm)

Stroke Symbol	1~50	51~100	101~150	151~200	201~250
	LT	LT	LT	LT	LT
φ20	128	153	178	—	—
φ25	132	157	182	—	—
φ32	134	159	184	209	—
φ40	163	188	213	238	263

# Series AXS

## Axial Foot Type (L)

AXL Bore Size Stroke  $\frac{S}{T}$

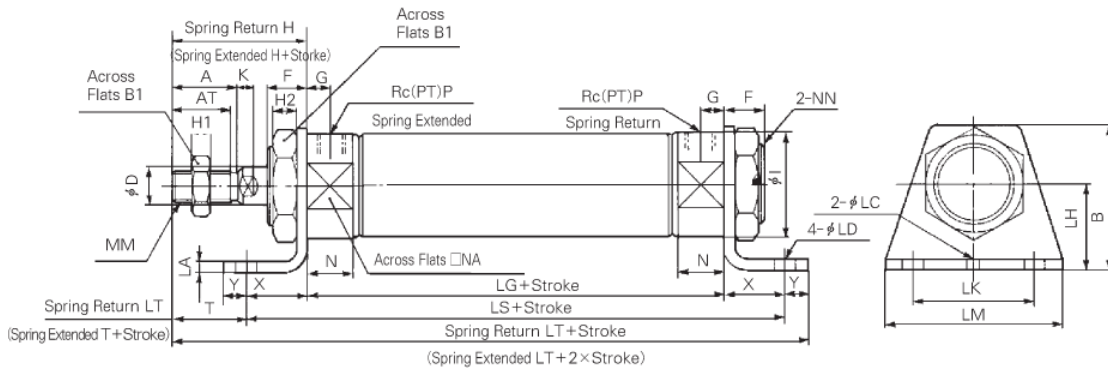

※ This Drawing is Spring Extended

(Unit : mm)

Bore Size	A	AT	B	B <sub>1</sub>	B <sub>2</sub>	D	F	G	H	H <sub>1</sub>	H <sub>2</sub>	I	K	LC	LD	LH	LA	LK	LM	MM	N	NA	NN	P	X	Y	T
φ20	18	15.5	40	13	26	8	13	8	41	5	8	27	5	4	6.8	25	3.2	40	55	M8×1.25	15	24	M20×1.5	1/8	20	8	21
φ25	22	19.5	47	17	32	10	13	8	45	6	8	33	5.5	4	6.8	28	3.2	40	55	M10×1.25	15	30	M26×1.5	1/8	20	8	25
φ32	22	19.5	47	17	32	12	13	8	45	6	8	37.5	5.5	4	6.8	28	3.2	40	55	M10×1.25	15	34.5	M26×1.5	1/8	20	8	25
φ40	24	21	54	22	41	14	16	11	50	8	10	46.5	7	4	7	30	3.2	55	75	M14×1.25	21.5	42.5	M32×2	1/4	23	10	27

### Stroke Dimension Adder

(Unit : mm)

Bore size	1~50			51~100			101~150			151~200			201~250		
	LG	LS	LT	LG	LS	LT	LG	LS	LT	LG	LS	LT	LG	LS	LT
φ20	87	127	156	112	152	181	137	177	206	-	-	-	-	-	-
φ25	87	127	160	112	152	185	137	177	210	-	-	-	-	-	-
φ32	89	129	162	114	154	187	139	179	212	164	204	237	-	-	-
φ40	113	159	196	138	184	221	163	209	246	188	234	271	213	259	296

ACP

APM

AS

**AX**

AM2

AM

AL

ALX

AQ

ADQ

AQ2

ADQ2

AJ

AJM

ABK

ACK1

NSK

AG

NGQ

AGX

GX

NP

ADR

AMR

NDM

ARD

NST

AST

ASTH

NLCD

NLCS

# Series AXS

## Rod Side Flange Type(F)

AXF Bore Size Stroke  $\frac{S}{T}$

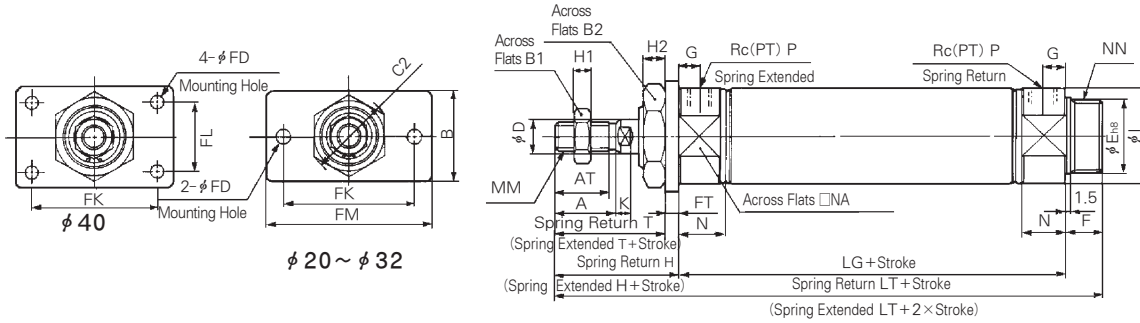

### Boss-Cut Type

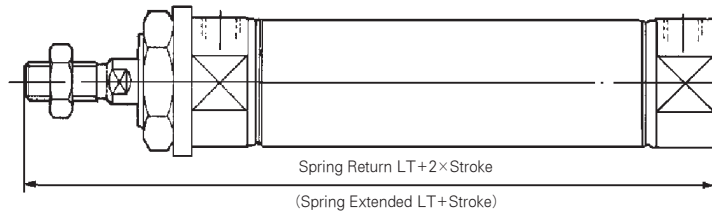

※ This drawing is spring extended

(Unit : mm)

Bore Size	A	AT	B	B <sup>1</sup>	B <sup>2</sup>	C <sup>2</sup>	D	E	F	FD	FT	FK	FL	FM	G	H	H <sup>1</sup>	H <sup>2</sup>	I	K	MM	N	NA	NN	P	T
φ 20	18	15.5	34	13	26	30	8	20 <sup>0</sup> <sub>-0.033</sub>	13	7	4	60	-	75	8	41	5	8	27	5	M8×1.25	15	24	M20×1.5	1/8	37
φ 25	22	19.5	40	17	32	37	10	26 <sup>0</sup> <sub>-0.033</sub>	13	7	4	60	-	75	8	45	6	8	33	5.5	M10×1.25	15	30	M26×1.5	1/8	41
φ 32	22	19.5	40	17	32	37	12	26 <sup>0</sup> <sub>-0.033</sub>	13	7	4	60	-	75	8	45	6	8	37.5	5.5	M10×1.25	15	34.5	M26×1.5	1/8	41
φ 40	24	21	52	22	41	47.3	14	32 <sup>0</sup> <sub>-0.039</sub>	16	7	5	66	36	82	11	50	8	10	46.5	7	M14×1.5	21.5	42.5	M32×2	1/4	45

### Stroke Dimension Adder

Stroke Symbol	1~50		51~100		101~150		151~200		201~250	
	LG	LT	LG	LT	LG	LT	LG	LT	LG	LT
φ 20	87	141	112	166	137	191	-	-	-	-
φ 25	87	145	112	170	137	195	-	-	-	-
φ 32	89	147	114	172	139	197	164	222	-	-
φ 40	113	179	138	204	163	229	188	254	213	279

### Boss-Cut Type

Stroke Symbol	1~50		51~100		101~150		151~200		201~250	
	LT	LT	LT	LT	LT	LT	LT	LT	LT	
φ 20	128	153	178	-	-	-	-	-	-	
φ 25	132	157	182	-	-	-	-	-	-	
φ 32	134	159	184	209	-	-	-	-	-	
φ 40	163	188	213	238	263	-	-	-	-	

Head Side Flange Type(G)

AXG Bore Size Stroke  $\frac{S}{T}$

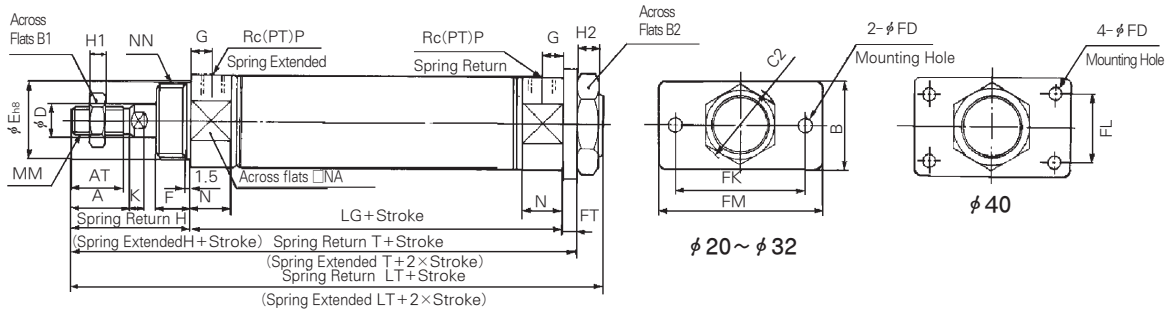

\*This Drawing is Spring Extended.

(Unit : mm)

Bore Size	A	AT	B	B <sub>1</sub>	B <sub>2</sub>	C	D	E	F	FD	FT	FK	FL	FM	G	H	H <sub>1</sub>	H <sub>2</sub>	I	K	MM	N	NA	NN	P
φ 20	18	15.5	34	13	26	30	8	20 <sup>0</sup> <sub>-0.033</sub>	13	7	4	60	-	75	8	41	5	8	27	5	M8×1.25	15	24	M20×1.5	1/8
φ 25	22	19.5	40	17	32	37	10	26 <sup>0</sup> <sub>-0.033</sub>	13	7	4	60	-	75	8	45	6	8	33	5.5	M10×1.25	15	30	M26×1.5	1/8
φ 32	22	19.5	40	17	32	37	12	26 <sup>0</sup> <sub>-0.033</sub>	13	7	4	60	-	75	8	45	6	8	37.5	5.5	M10×1.25	15	34.5	M26×1.5	1/8
φ 40	24	21	52	22	41	47.3	14	32 <sup>0</sup> <sub>-0.039</sub>	16	7	5	66	36	82	11	50	8	10	46.5	7	M14×1.5	21.5	42.5	M30×2	1/4

Stroke Dimension Adder

(Unit : mm)

Stroke Symbol	1~50			51~100			101~150			151~200			201~250			
	Bore size	LG	T	LT	Bore size	LG	T	LT	Bore size	LG	T	LT	Bore size	LG	T	LT
φ 20	87	132	141	112	157	166	137	182	191	-	-	-	-	-	-	-
φ 25	87	136	145	112	161	170	137	186	195	-	-	-	-	-	-	-
φ 32	89	138	147	114	163	172	139	188	197	164	213	222	-	-	-	-
φ 40	113	168	179	138	193	204	163	218	229	188	243	254	213	268	279	-

ACP

APM

AS

**AX**

AM2

AM

AL  
ALX

AQ

ADQ

AQ2  
ADQ2

AJ  
AJM

ABK

ACK1

NSK

AG

NGQ

AGX  
GX

NP

ADR

AMR

NDM

ARD

NST

AST

ASTH

NLCD

NLCS

# Series AXS

## Single Clevis Type(C)

AXC Bore Size Stroke  $\frac{S}{T}$

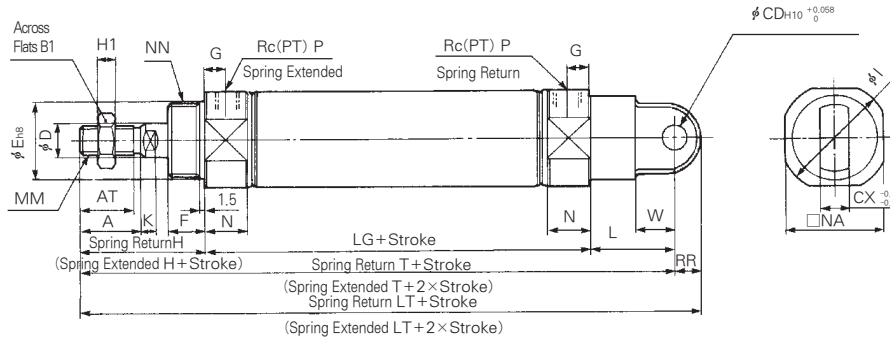

※ This Drawing is Spring Extended

(Unit : mm)

Bore Size	A	AT	B1	CD	CX	D	E	F	G	H	H1	I	K	L	MM	N	NA	NN	P	RR	W
φ20	18	15.5	13	9	10	8	20 <sup>0</sup> <sub>-0.033</sub>	13	8	41	5	27	5	30	M8×1.25	15	24	M20×1.5	1/8	9	14
φ25	22	19.5	17	9	10	10	26 <sup>0</sup> <sub>-0.033</sub>	13	8	45	6	33	5.5	30	M10×1.25	15	30	M26×1.5	1/8	9	14
φ32	22	19.5	17	9	10	12	26 <sup>0</sup> <sub>-0.033</sub>	13	8	45	6	37.5	5.5	30	M10×1.25	15	34.5	M26×1.5	1/8	9	14
φ40	24	21	22	10	15	14	32 <sup>0</sup> <sub>-0.039</sub>	16	11	50	8	46.5	7	39	M14×1.5	21.5	42.5	M32×2	1/4	11	18

### Stroke Dimension Adder

Stroke Symbol	1~50			51~100			101~150			151~200			201~250			
	Bore size	LG	T	LT	LG	T	LT	LG	T	LT	LG	T	LT	LG	T	LT
φ20		87	158	167	112	183	192	137	208	217	—	—	—	—	—	—
φ25		87	162	171	112	187	196	137	212	221	—	—	—	—	—	—
φ32		89	164	173	114	189	198	139	214	223	164	239	248	—	—	—
φ40		113	202	213	138	227	238	163	252	263	188	277	288	213	302	313

Double Clevis Type(D)

AXD (Bore Size) (Stroke)  $\frac{S}{T}$

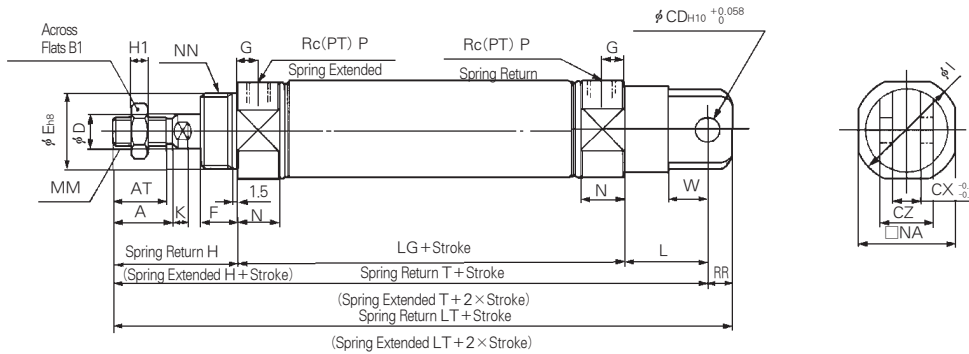

※ This drawing is spring extended

(Unit : mm)

Bore Size	A	AT	B1	CD	CX	CZ	D	E	F	G	H	H <sub>1</sub>	I	K	L	MM	N	NA	NN	P	RR	W
φ20	18	15.5	13	9	10	19	8	20 <sup>0</sup> <sub>-0.033</sub>	13	8	41	5	27	5	30	M8×1.25	15	24	M20×1.5	1/8	9	14
φ25	22	19.5	17	9	10	19	10	26 <sup>0</sup> <sub>-0.033</sub>	13	8	45	6	33	5.5	30	M10×1.25	15	30	M26×1.5	1/8	9	14
φ32	22	19.5	17	9	10	19	12	26 <sup>0</sup> <sub>-0.033</sub>	13	8	45	6	37.5	5.5	30	M10×1.25	15	34.5	M25×1.5	1/8	9	14
φ40	24	21	22	10	15	30	14	32 <sup>0</sup> <sub>-0.039</sub>	16	11	50	8	46.5	7	39	M14×1.5	21.5	42.5	M32×2	1/4	11	18

Stroke Dimension Adder

Stroke Symbol	1~50			51~100			101~150			151~200			201~250		
	LG	T	LT	LG	T	LT	LG	T	LT	LG	T	LT	LG	T	LT
φ20	87	158	167	112	183	192	137	208	217	—	—	—	—	—	—
φ25	87	162	171	112	187	196	137	212	221	—	—	—	—	—	—
φ32	89	164	173	114	189	198	139	214	223	164	239	248	—	—	—
φ40	113	202	213	138	227	238	163	252	263	188	277	288	213	302	313

- ACP
- APM
- AS
- AX**
- AM2
- AM
- AL
- ALX
- AQ
- ADQ
- AQ2
- ADQ2
- AJ
- AJM
- ABK
- ACK1
- NSK
- AG
- NGQ
- AGX
- GX
- NP
- ADR
- AMR
- NDM
- ARD
- NST
- AST
- ASTH
- NLCD
- NLCS

# Series AXS

## Rod Side Trunnion Type(U)

AXU Bore Size Stroke  $\frac{S}{T}$

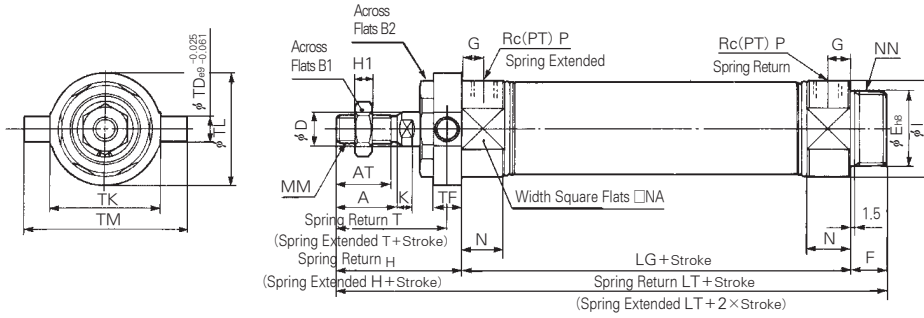

### Boss-Cut Type

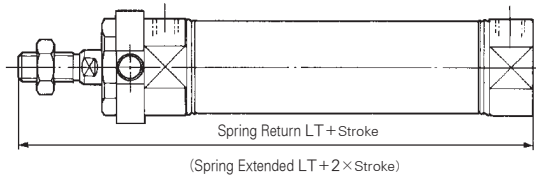

※ This drawing is spring extended

(Unit : mm)

Bore size	A	AT	B <sub>1</sub>	B <sub>2</sub>	D	E	F	G	H	H <sub>1</sub>	I	K	MM	N	NA	NN	P	TD	TF	TK	TL	TM	T
φ20	18	15.5	13	26	8	20 <sup>0</sup> <sub>-0.033</sub>	13	8	41	5	27	5	M8×1.25	15	24	M20×1.5	1/8	8	10	32	32	52	36
φ25	22	19.5	17	32	10	26 <sup>0</sup> <sub>-0.033</sub>	13	8	45	6	33	5.5	M10×1.25	15	30	M26×1.5	1/8	9	10	40	40	60	40
φ32	22	19.5	17	32	12	26 <sup>0</sup> <sub>-0.033</sub>	13	8	45	6	37.5	5.5	M10×1.25	15	34.5	M26×1.5	1/8	9	10	40	40	60	40
φ40	24	21	22	41	14	32 <sup>0</sup> <sub>-0.039</sub>	16	11	50	8	46.5	7	M14×1.5	21.5	42.5	M32×2	1/4	10	11	53	53	77	44.5

### Stroke Dimension Adder

Stroke Symbol	1~50		51~100		101~200		151~200		201~250	
	LG	LT	LG	LT	LG	LT	LG	LT	LG	LT
φ20	87	141	112	166	137	191	—	—	—	—
φ25	87	145	112	170	137	195	—	—	—	—
φ32	89	147	114	172	139	197	164	222	—	—
φ40	113	179	138	204	163	229	188	254	213	279

### Boss-Cut Type

Stroke Symbol	1~50	51~100	101~150	151~200	201~250
	LT	LT	LT	LT	LT
φ20	128	153	178	—	—
φ25	132	157	182	—	—
φ32	134	159	184	209	—
φ40	163	188	213	238	263



## Integrated Clevis Type(E)

AXE Bore Size Stroke ST

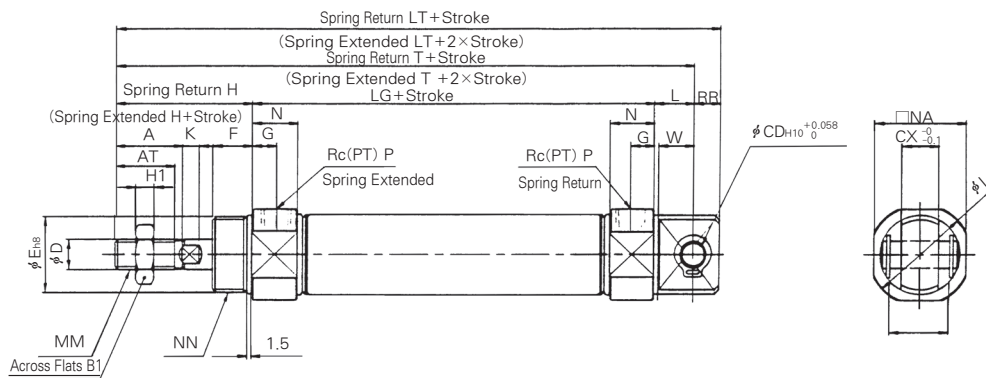

※ This drawing is spring extended.

(Unit : mm)

Bore Size	A	AT	B <sub>1</sub>	CD	CX	D	E	F	G	H	H <sub>1</sub>	I	K	L	LV	MM	N	NA	NN	P	RR	W
φ20	18	15.5	13	8	12	8	20 <sup>0</sup> <sub>-0.033</sub>	13	8	41	5	27	5	12	18.4	M8×1.25	15	24	M20×1.5	1/8	9	11.5
φ25	22	19.5	17	8	12	10	26 <sup>0</sup> <sub>-0.033</sub>	13	8	45	6	33	5.5	12	18.4	M10×1.25	15	30	M26×1.5	1/8	9	11.5
φ32	22	19.5	17	10	20	12	26 <sup>0</sup> <sub>-0.033</sub>	13	8	45	6	37.5	5.5	15	28	M10×1.25	15	34.5	M26×1.5	1/8	12	14.5
φ40	24	21	22	10	20	14	32 <sup>0</sup> <sub>-0.039</sub>	16	11	50	8	46.5	7	15	28	M14×1.5	21.5	42.5	M32×2	1/4	12	14.5

### Stroke Dimension Adder

(Unit : mm)

Stroke Symbol Bore size	1~50			51~100			101~150			151~200			201~250		
	LG	T	LT	LG	T	LT	LG	T	LT	LG	T	LT	LG	T	LT
φ20	87	140	149	112	165	174	137	190	199	—	—	—	—	—	—
φ25	87	144	153	112	169	178	137	194	203	—	—	—	—	—	—
φ32	89	149	161	114	174	186	139	199	211	164	224	236	—	—	—
φ40	113	178	190	138	203	215	163	228	240	188	253	265	213	278	290

ACP

APM

AS

**AX**

AM2

AM

AL

ALX

AQ

ADQ

AQ2

ADQ2

AJ

AJM

ABK

ACK1

NSK

AG

NGQ

AGX

GX

NP

ADR

AMR

NDM

ARD

NST

AST

ASTH

NLCD

NLCS

# Series AXS

## Head Side Trunnion Type(T)

AXT **Bore Size** **Stroke** ST

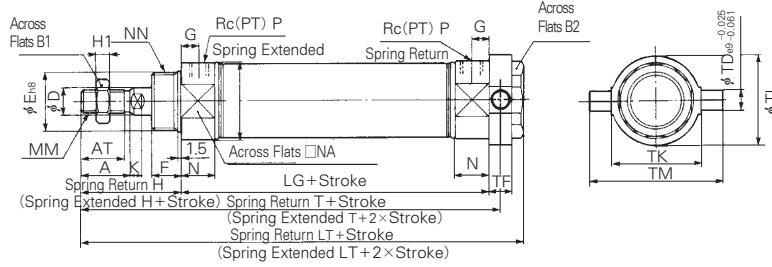

(Unit : mm)

\* This drawing is spring extended

Bore Size	A	AT	B1	B2	D	E <sup>h6</sup>	F	G	H	H <sub>i</sub>	I	K	MM	N	NA	NN	P	TD	TF	TK	TL	TM
φ20	18	15.5	13	26	8	20 <sup>0</sup> <sub>-0.033</sub>	13	8	41	5	27	5	M8×1.25	15	24	M20×1.5	1/8	8	10	32	32	52
φ25	22	19.5	17	32	10	26 <sup>0</sup> <sub>-0.033</sub>	13	8	45	6	33	5.5	M10×1.25	15	30	M26×1.5	1/8	9	10	40	40	60
φ32	22	19.5	17	32	12	26 <sup>0</sup> <sub>-0.033</sub>	13	8	45	6	37.5	5.5	M10×1.25	15	34.5	M26×1.5	1/8	9	10	40	40	60
φ40	24	21	22	41	14	32 <sup>0</sup> <sub>-0.039</sub>	16	11	50	8	46.5	7	M14×1.5	21.5	42.5	M32×2	1/4	10	11	53	53	77

Stroke Symbol	1~50			51~100			101~150			151~200			201~250		
	LG	T	LT	LG	T	LT	LG	T	LT	LG	T	LT	LG	T	LT
φ20	87	133	143	112	158	168	137	183	193	-	-	-	-	-	-
φ25	87	137	147	112	162	172	137	187	197	-	-	-	-	-	-
φ32	89	139	149	114	164	174	139	189	199	164	214	224	-	-	-
φ40	113	168.5	179	138	193.5	204	163	218.5	229	188	243.5	254	213	268.5	279

## Reed Switch Setting Position (Stroke End)

W5

(Unit : mm)

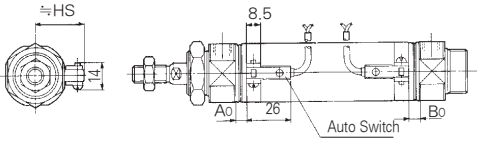

### Auto Switch Mounting, Minimum Possible Cylinder Stroke

Auto Switch Type	No. of auto switch				1pc
	2pcs.		npcs.		
	Different Surface	Same Surface	Different Surface	Same Surface	
W5	15	50	15+45( $\frac{n-2}{2}$ ) (n=2,4,6,8...)	50+45(n-2)	10

### Auto Switch Setting Position(Stroke End)

(Unit : mm)

Auto Switch Type	Bore Size	Spring Return					BO	AO	Spring Extended					HS
		AO							BO					
		~50 <sup>ST</sup>	51~100 <sup>ST</sup>	101~150 <sup>ST</sup>	151~200 <sup>ST</sup>	201~250 <sup>ST</sup>			~50 <sup>ST</sup>	51~100 <sup>ST</sup>	101~150 <sup>ST</sup>	151~200 <sup>ST</sup>	201~250 <sup>ST</sup>	
W5	φ20	32	57	82	107	132	6	7	31	56	81	106	131	22.5
	φ25	32	57	82	107	132	6	7	31	56	81	106	131	25
	φ32	33	58	83	108	133	7	8	32	57	82	107	132	28.5
	φ40	38	63	88	113	138	12	13	37	62	87	112	137	32.5